



Robert Bosch Power Tools GmbH
70538 Stuttgart
GERMANY

www.bosch-pt.com

1 609 92A 1TE (2013.01) O / 39 ASIA



1 609 92A 1TE

GSR | GSB Professional

14,4 V-Li | 18 V-Li



- en** Original instructions
- cn** 正本使用说明书
- tw** 原始使用說明書
- ko** 사용 설명서 원본
- th** หนังสือคู่มือการใช้งานฉบับต้นแบบ
- id** Petunjuk-Petunjuk untuk Penggunaan Orisinal
- vi** Bản gốc hướng dẫn sử dụng





English Page 3
 中文 页 7
 中文 頁 11
 한국어 면 14
 ภาษาไทย หน้า 18
 Bahasa Indonesia Halaman 23
 Tiếng Việt Trang 28



English

General Power Tool Safety Warnings

⚠ WARNING Read all safety warnings and all instructions. Failure to follow the warnings and instructions may result in electric shock, fire and/or serious injury.

Save all warnings and instructions for future reference.

The term "power tool" in the warnings refers to your mains-operated (corded) power tool or battery-operated (cordless) power tool.

Work area safety

- ▶ **Keep work area clean and well lit.** Cluttered or dark areas invite accidents.
- ▶ **Do not operate power tools in explosive atmospheres, such as in the presence of flammable liquids, gases or dust.** Power tools create sparks which may ignite the dust or fumes.
- ▶ **Keep children and bystanders away while operating a power tool.** Distractions can cause you to lose control.

Electrical safety

- ▶ **Power tool plugs must match the outlet. Never modify the plug in any way. Do not use any adapter plugs with earthed (grounded) power tools.** Unmodified plugs and matching outlets will reduce risk of electric shock.
- ▶ **Avoid body contact with earthed or grounded surfaces, such as pipes, radiators, ranges and refrigerators.** There is an increased risk of electric shock if your body is earthed or grounded.
- ▶ **Do not expose power tools to rain or wet conditions.** Water entering a power tool will increase the risk of electric shock.
- ▶ **Do not abuse the cord. Never use the cord for carrying, pulling or unplugging the power tool. Keep cord away from heat, oil, sharp edges and moving parts.** Damaged or entangled cords increase the risk of electric shock.
- ▶ **When operating a power tool outdoors, use an extension cord suitable for outdoor use.** Use of a cord suitable for outdoor use reduces the risk of electric shock.
- ▶ **If operating a power tool in a damp location is unavoidable, use a residual current device (RCD) protected supply.** Use of an RCD reduces the risk of electric shock.

Personal safety

- ▶ **Stay alert, watch what you are doing and use common sense when operating a power tool. Do not use a power tool while you are tired or under the influence of drugs, alcohol or medication.** A moment of inattention while operating power tools may result in serious personal injury.
- ▶ **Use personal protective equipment. Always wear eye protection.** Protective equipment such as dust mask, non-skid safety shoes, hard hat, or hearing protection used for appropriate conditions will reduce personal injuries.

- ▶ **Prevent unintentional starting. Ensure the switch is in the off-position before connecting to power source and/or battery pack, picking up or carrying the tool.** Carrying power tools with your finger on the switch or energising power tools that have the switch on invites accidents.
- ▶ **Remove any adjusting key or wrench before turning the power tool on.** A wrench or a key left attached to a rotating part of the power tool may result in personal injury.
- ▶ **Do not overreach. Keep proper footing and balance at all times.** This enables better control of the power tool in unexpected situations.
- ▶ **Dress properly. Do not wear loose clothing or jewelry. Keep your hair, clothing and gloves away from moving parts.** Loose clothes, jewellery or long hair can be caught in moving parts.
- ▶ **If devices are provided for the connection of dust extraction and collection facilities, ensure these are connected and properly used.** Use of dust collection can reduce dust-related hazards.

Power tool use and care

- ▶ **Do not force the power tool. Use the correct power tool for your application.** The correct power tool will do the job better and safer at the rate for which it was designed.
- ▶ **Do not use the power tool if the switch does not turn it on and off.** Any power tool that cannot be controlled with the switch is dangerous and must be repaired.
- ▶ **Disconnect the plug from the power source and/or the battery pack from the power tool before making any adjustments, changing accessories, or storing power tools.** Such preventive safety measures reduce the risk of starting the power tool accidentally.
- ▶ **Store idle power tools out of the reach of children and do not allow persons unfamiliar with the power tool or these instructions to operate the power tool.** Power tools are dangerous in the hands of untrained users.
- ▶ **Maintain power tools. Check for misalignment or binding of moving parts, breakage of parts and any other condition that may affect the power tool's operation. If damaged, have the power tool repaired before use.** Many accidents are caused by poorly maintained power tools.
- ▶ **Keep cutting tools sharp and clean.** Properly maintained cutting tools with sharp cutting edges are less likely to bind and are easier to control.
- ▶ **Use the power tool, accessories and tool bits etc. in accordance with these instructions, taking into account the working conditions and the work to be performed.** Use of the power tool for operations different from those intended could result in a hazardous situation.

Battery tool use and care

- ▶ **Recharge only with the charger specified by the manufacturer.** A charger that is suitable for one type of battery pack may create a risk of fire when used with another battery pack.

4 | English

- ▶ **Use power tools only with specifically designated battery packs.** Use of any other battery packs may create a risk of injury and fire.
- ▶ **When battery pack is not in use, keep it away from other metal objects, like paper clips, coins, keys, nails, screws or other small metal objects, that can make a connection from one terminal to another.** Shorting the battery terminals together may cause burns or a fire.
- ▶ **Under abusive conditions, liquid may be ejected from the battery; avoid contact. If contact accidentally occurs, flush with water. If liquid contacts eyes, additionally seek medical help.** Liquid ejected from the battery may cause irritation or burns.

Service

- ▶ **Have your power tool serviced by a qualified repair person using only identical replacement parts.** This will ensure that the safety of the power tool is maintained.

Safety Warnings for Drills and Screwdriver**GSB 14,4 V-LI / GSB 18 V-LI**

- ▶ **Wear ear protectors when impact drilling.** Exposure to noise can cause hearing loss.

GSR 14,4 V-LI / GSR 18 V-LI / GSB 14,4 V-LI / GSB 18 V-LI

- ▶ **Hold power tool by insulated gripping surfaces, when performing an operation where the cutting accessory or fastener may contact hidden wiring.** Cutting accessory and fasteners contacting a "live" wire may make exposed metal parts of the power tool "live" and could give the operator an electric shock.
- ▶ **Use auxiliary handle(s), if supplied with the tool.** Loss of control can cause personal injury.
- ▶ **Use appropriate detectors to determine if utility lines are hidden in the work area or call the local utility company for assistance.** Contact with electric lines can lead to fire and electric shock. Damaging a gas line can lead to explosion. Penetrating a water line causes property damage.
- ▶ **Switch off the power tool immediately when the tool insert jams. Be prepared for high reaction torque that can cause kickback.** The tool insert jams when:
 - the power tool is subject to overload or
 - it becomes wedged in the workpiece.
- ▶ **Hold the machine with a firm grip.** High reaction torque can briefly occur while driving in and loosening screws.
- ▶ **Secure the workpiece.** A workpiece clamped with clamping devices or in a vice is held more secure than by hand.
- ▶ **Keep your workplace clean.** Blends of materials are particularly dangerous. Dust from light alloys can burn or explode.

- ▶ **Do not open the battery.** Danger of short-circuiting.



Protect the battery against heat, e. g., against continuous intense sunlight, fire, water, and moisture. Danger of explosion.



- ▶ **In case of damage and improper use of the battery, vapours may be emitted. Ventilate the area and seek medical help in case of complaints.** The vapours can irritate the respiratory system.
- ▶ **Use the battery only in conjunction with your Bosch power tool.** This measure alone protects the battery against dangerous overload.
- ▶ **Use only original Bosch batteries with the voltage listed on the nameplate of your power tool.** When using other batteries, e. g. imitations, reconditioned batteries or other brands, there is danger of injury as well as property damage through exploding batteries.









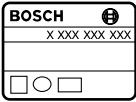

Additional Safety and Working Instructions









- ▶ **Dusts from materials such as lead-containing coatings, some wood types, minerals and metal can be harmful to one's health and cause allergic reactions, lead to respiratory infections and/or cancer.** Materials containing asbestos may only be worked by specialists.
 - Provide for good ventilation of the working place.
 - It is recommended to wear a P2 filter-class respirator.
 Observe the relevant regulations in your country for the materials to be worked.
- ▶ **Prevent dust accumulation at the workplace.** Dusts can easily ignite.
- ▶ **Before any work on the machine (e. g., maintenance, tool change, etc.) as well as during transport and storage, set the rotational direction switch to the centre position.** Unintentional actuation of the On/Off switch can lead to injuries.
- ▶ **The battery is supplied partially charged. To ensure full battery capacity, completely charge the battery in the battery charger before using for the first time.**
- ▶ **The battery is equipped with a NTC temperature control which allows charging only within a temperature range of between 0 °C and 45 °C. A long battery service life is achieved in this manner.**
- ▶ **Read the operating instructions of the battery charger.**
- ▶ **Apply the power tool to the screw only when it is switched off.** Rotating tool inserts can slip off.
- ▶ **Adjust the gear switch only when the machine is at a complete stop.**
- ▶ **Always push the gear selector and turn the operating mode selector switch through to the stop.** Otherwise, the machine can become damaged.

► **In case of excessive loading, e. g., prolonged blocking of the application tool, the electronics switch off the power tool. After switching on again, the power tool can be used again as intended for. In case of continued overload, the power tool will switch off again in order to prevent damage to the motor.**

Symbols

The following symbols are important for reading and understanding the operating instructions. Please take note of the symbols and their meaning. The correct interpretation of the symbols will help you to use the machine in a better and safer manner.

Symbol	Meaning
	GSR 14,4 V-Li/GSR 18 V-Li/ GSB 14,4 V-Li/GSB 18 V-Li: Cordless screwdriver/Combination cordless drill Grey-marked area: Handle (insulated gripping surface)
	Article number X XXX XXX XXX
	Read all safety warnings and all instructions
	Before any work on the machine itself, remove the battery
	Always wear ear protection.
	Movement direction
	Reaction direction
	Drilling and screwdriving
	Impact drilling
	Low speed
	High speed

Symbol	Meaning
	Switching On
	Switching Off
	Right/left rotation
U	Rated voltage
n_s	Impact rate
$n_0 1$	No-load speed (1. gear)
$n_0 2$	No-load speed (2. gear)
M	Maximum torque according to ISO 5393
	Brickwork
	Metal
	Wood
\emptyset	Drilling diameter, max.
	Max. screw dia.
	Chuck clamping range
	Weight according to EPTA-Procedure 01:2014
*	dependent of the battery pack being used

Delivery Scope

Cordless screwdriver/Combination cordless drill.
Battery, application tools and other accessories shown or described are not part of the standard delivery scope.

A complete overview of accessories can be found in our accessories program.

Intended Use

The machine is intended for driving in and loosening screws as well as for drilling in wood, metal, ceramics and plastic. GSB machines are additionally intended for impact drilling in bricks, brickwork and masonry.

Technical Data

The technical data of the machine are listed in the table on page 33.

Please observe the article number on the type plate of your machine. The trade names of the individual machines may vary.

Mounting and Operation

Action	Figure	Page
Removing the battery	1	34
Inserting the battery	2	34
Mounting application tools	3	34
Reversing the rotational direction	4	35
Setting the torque	5	35
Selecting the drilling position	6	36
Setting the operating mode	7	36
Gear selection, mechanical	8	36
Switching On and Off	9	37
Selecting Accessories	-	38

Maintenance and Cleaning

- **For safe and proper working, always keep the machine and ventilation slots clean.**

Clean the application tool, the tool holder, the power tool's ventilations slots, and the battery's ventilation slots each time after using.

After-sales Service and Application Service

Our after-sales service responds to your questions concerning maintenance and repair of your product as well as spare parts. Exploded views and information on spare parts can also be found under:

www.bosch-pt.com

Bosch's application service team will gladly answer questions concerning our products and their accessories.

In all correspondence and spare parts order, please always include the 10-digit article number given on the type plate of the machine.

People's Republic of China

China Mainland

Bosch Power Tools (China) Co., Ltd.
567, Bin Kang Road
Bin Jiang District 310052
Hangzhou, P. R. China
Service Hotline: 4008268484
Fax: (0571) 87774502
E-Mail: contact.ptcn@cn.bosch.com
www.bosch-pt.com.cn

HK and Macau Special Administrative Regions

Robert Bosch Hong Kong Co. Ltd.
21st Floor, 625 King's Road
North Point, Hong Kong
Customer Service Hotline: +852 2101 0235
Fax: +852 2590 9762
E-Mail: info@hk.bosch.com
www.bosch-pt.com.hk

Indonesia

PT. Multi Mayaka
Kawasan Industri Pulogadung
Jalan Rawa Gelam III No. 2
Jakarta 13930
Indonesia
Tel.: (021) 46832522
Fax: (021) 46828645/6823
E-Mail: sales@multimayaka.co.id
www.bosch-pt.co.id

Philippines

Robert Bosch, Inc.
28th Floor Fort Legend Towers,
3rd Avenue corner 31st Street,
Fort Bonifacio Global City,
1634 Taguig City, Philippines
Tel.: (02) 8703871
Fax: (02) 8703870
matheus.contiero@ph.bosch.com
www.bosch-pt.com.ph

Bosch Service Center:
9725-27 Kamagong Street
San Antonio Village
Makati City, Philippines
Tel.: (02) 8999091
Fax: (02) 8976432
rosalie.dagdagan@ph.bosch.com

Malaysia

Robert Bosch (S.E.A.) Sdn. Bhd.
No. 8A, Jalan 13/6
G.P.O. Box 10818
46200 Petaling Jaya
Selangor, Malaysia
Tel.: (03) 79663194
Fax: (03) 79583838
cheehoe.on@my.bosch.com
Toll-Free: 1800 880188
www.bosch-pt.com.my

Thailand

Robert Bosch Ltd.
 Liberty Square Building
 No. 287, 11 Floor
 Silom Road, Bangrak
 Bangkok 10500
 Tel.: 02 6311879 – 18 88 (10 lines)
 Fax: 02 2384783
 Robert Bosch Ltd., P. O. Box 2054
 Bangkok 10501, Thailand
 Bosch Service – Training Centre
 2869-2869/1 Soi Ban Kluay
 Rama IV Road (near old Paknam Railway)
 Prakanong District
 10110 Bangkok
 Thailand
 Tel.: 02 67178 00 – 4
 Fax: 02 2494296
 Fax: 02 2495299

Singapore

Robert Bosch (SEA) Pte. Ltd.
 11 Bishan Street 21
 Singapore 573943
 Tel.: 6571 2772
 Fax: 6350 5315
 leongheng.leow@sg.bosch.com
 Toll-Free: 1800 3338333
 www.bosch-pt.com.sg

Vietnam

Robert Bosch Vietnam Co. Ltd
 10/F, 194 Golden Building
 473 Dien Bien Phu Street
 Ward 25, Binh Thanh District
 84 Ho Chi Minh City
 Vietnam
 Tel.: (08) 6258 3690 ext. 413
 Fax: (08) 6258 3692
 hieu.lagia@vn.bosch.com
 www.bosch-pt.com

Australia, New Zealand and Pacific Islands

Robert Bosch Australia Pty. Ltd.
 Power Tools
 Locked Bag 66
 Clayton South VIC 3169
 Customer Contact Center
 Inside Australia:
 Phone: (01300) 307044
 Fax: (01300) 307045
 Inside New Zealand:
 Phone: (0800) 543353
 Fax: (0800) 428570
 Outside AU and NZ:
 Phone: +61 3 95415555
 www.bosch.com.au

Transport

The contained lithium-ion batteries are subject to the Dangerous Goods Legislation requirements. The user can transport the batteries by road without further requirements. When being transported by third parties (e.g.: air transport or forwarding agency), special requirements on packaging and labelling must be observed. For preparation of the item being shipped, consulting an expert for hazardous material is required. Dispatch batteries only when the housing is undamaged. Tape or mask off open contacts and pack up the battery in such a manner that it cannot move around in the packaging. Please also observe possibly more detailed national regulations.

Disposal

The machine, rechargeable batteries, accessories and packaging should be sorted for environmental-friendly recycling.

Do not dispose of power tools and batteries/rechargeable batteries into household waste!

Battery packs/batteries:**Li-ion:**

Please observe the instructions in section "Transport", page 7.

Subject to change without notice.

中文**电动工具通用安全警告**

警告 阅读所有警告和所有说明！不遵照以下警告和说明会导致电击、着火和/或严重伤害。

保存所有警告和说明书以备查阅。

在所有下列的警告中术语“电动工具”指市电驱动（有线）电动工具或电池驱动（无线）电动工具。

工作场地的安全

- ▶ **保持工作场地清洁和明亮。** 混乱和黑暗的场地会引发事故。
- ▶ **不要在易爆环境，如有易燃液体、气体或粉尘的环境下操作电动工具。** 电动工具产生的火花会点燃粉尘或气体。
- ▶ **让儿童和旁观者离开后操作电动工具。** 注意力不集中会使操作者失去对工具的控制。

电气安全

- ▶ **电动工具插头必须与插座相配。绝不能以任何方式改装插头。** 需接地的电动工具不能使用任何转换插头。未经改装的插头和相配的插座将减少电击危险。

8 | 中文

- ▶ **避免人体接触接地表面，如管道、散热片和冰箱。** 如果你身体接地会增加电击危险。
- ▶ **不得将电动工具暴露在雨中或潮湿环境中。** 水进入电动工具将增加电击危险。
- ▶ **不得滥用电线。** 绝不用电线搬运、拉动电动工具或拔出其插头。使电线远离热源、油、锐边或运动部件。受损或缠绕的软线会增加电击危险。
- ▶ **当在户外使用电动工具时，使用适合户外使用的外接软线。** 适合户外使用的软线将减少电击危险。
- ▶ **如果在潮湿环境下操作电动工具是不可避免的，应使用剩余电流动作保护器（RCD）。** 使用 RCD 可减小电击危险。

人身安全

- ▶ **保持警觉，当操作电动工具时关注所从事的操作并保持清醒。** 当你感到疲倦，或在有药物、酒精或治疗反应时，不要操作电动工具。在操作电动工具时瞬间的疏忽会导致严重人身伤害。
- ▶ **使用个人防护装置。始终佩戴护目镜。** 安全装置，诸如适当条件下使用防尘面具、防滑安全鞋、安全帽、听力防护等装置能减少人身伤害。
- ▶ **防止意外启动。确保开关在连接电源和 / 或电池盒、拿起或搬运工具时处于关断位置。** 手指放在已接通电源的开关上或开关处于接通时插入插头可能会导致危险。
- ▶ **在电动工具接通之前，拿掉所有调节钥匙或扳手。** 遗留在电动工具旋转零件上的扳手或钥匙会导致人身伤害。
- ▶ **手不要伸展得太长。时刻注意立足点和身体平衡。** 这样在意外情况下能很好地控制电动工具。
- ▶ **着装适当。不要穿宽松衣服或佩戴饰品。** 让你的衣服、手套和头发远离运动部件。宽松衣服、佩饰或长发可能会卷入运动部件中。
- ▶ **如果提供了与排屑、集尘设备连接用的装置，要确保他们连接完好且使用得当。** 使用这些装置可减少尘屑引起的危险。

电动工具使用和注意事项

- ▶ **不要滥用电动工具，根据用途使用适当的电动工具。** 选用适当设计的电动工具会使你工作更有效、更安全。
- ▶ **如果开关不能接通或关断工具电源，则不能使用该电动工具。** 不能用开关来控制的电动工具是危险的且必须进行修理。
- ▶ **在进行任何调节、更换附件或贮存电动工具之前，必须从电源上拔掉插头和 / 或使电池盒与工具脱开。** 这种防护性措施将减少工具意外起动的危险。
- ▶ **将闲置不用的电动工具贮存在儿童所及范围之外，并且不要让不熟悉电动工具或对这些说明不了解的人操作电动工具。** 电动工具在未经培训的用户手中是危险的。

- ▶ **保养电动工具。检查运动件是否调整到位或卡住，检查零件破损情况和影响电动工具运行的其他状况。** 如有损坏，电动工具应在使用前修理好。许多事故由维护不良的电动工具引发。
- ▶ **保持切削刀具锋利和清洁。** 保养良好的有锋利切削刃的刀具不易卡住而且容易控制。
- ▶ **按照使用说明书，考虑作业条件和进行的作业来使用电动工具、附件和工具的刀头。** 将电动工具用于那些与其用途不符的操作可能会导致危险。

电池式工具使用和注意事项

- ▶ **只用制造商规定的充电器充电。** 将适用于某种电池盒的充电器用到其他电池盒时会发生着火危险。
- ▶ **只有在配有专用电池盒的情况下才使用电动工具。** 使用其他电池盒会发生损坏和着火危险。
- ▶ **当电池盒不用时，将它远离其他金属物体，例如回形针、硬币、钥匙、钉子、螺钉或其他小金属物体，以防一端与另一端连接。** 电池端子短路会引起燃烧或火灾。
- ▶ **在滥用条件下，液体会从电池中溅出，避免接触。** 如果意外碰到了，用水冲洗。如果液体碰到了眼睛，还要寻求医疗帮助。从电池中溅出的液体会发生腐蚀或燃烧。

维修

- ▶ **将你的电动工具送交专业维修人员，使用同样的备件进行修理。** 这样将确保所维修的电动工具的安全性。

针对电钻和电动扳手的安规章

GSB 14,4 V-LI / GSB 18 V-LI

- ▶ **使用冲击电钻时要戴好耳罩。** 暴露在噪声中会引起听力损伤。

GSR 14,4 V-LI / GSR 18 V-LI /

GSB 14,4 V-LI / GSB 18 V-LI

- ▶ **安装在机器上的工具或螺丝如果可能切断隐藏的电线，一定要按住绝缘手柄操作电动工具。** 电动工具如果割断了带电的电线，机器上的金属部件会导电，并进而导致操作者触电。
- ▶ **如果电动工具提供了辅助手柄便要使用它。** 操作时失控可能导致伤害。
- ▶ **使用合适的侦测器，以便找出隐藏着的电源线的位**置。或者向当地的供电单位索取相关资料。钻穿电线会造成火灾并遭受电击。损坏瓦斯管会引起爆炸。如果水管被刺穿了会导致财物损失。
- ▶ **如果安装在机器上的工具被夹住了，必须马上关闭电动工具并保持镇静。** 此时机器会产生极高的反应力矩，并进而造成回击。安装在机器上的工具容易被夹住如果：
 - 电动工具超荷了，或者
 - 安装在机器上的工具在工件中歪斜了。

- ▶ **务必握紧电动工具。** 在拧紧和放松螺丝时，可能出现短暂的强大反击。
- ▶ **固定好工件。** 使用固定装置或老虎钳固定工件，会比用手握工件更牢固。
- ▶ **工作场所必须保持清洁。** 不同的工作尘经过混合后容易产生化学反应，十分危险。轻金属尘容易着火或引起爆炸。
- ▶ **切勿打开蓄电池。** 可能造成短路。



保护蓄电池免受高温（例如长期日照），火焰，水和湿气的侵害。有爆炸的危险。



- ▶ **如果蓄电池损坏了，或者未按照规定使用蓄电池，蓄电池中会散发出有毒蒸汽。工作场所必须保持空气流通，如果身体有任何不适必须马上就医。** 蓄电池散发的蒸汽会刺激呼吸道。
- ▶ **本蓄电池只能配合博世的电动工具一起使用。** 这样才能确保蓄电池不会过载。
- ▶ **只能使用博世原厂的蓄电池。** 电池的电压必须和电动工具铭牌上规定的电压相符。使用其他的蓄电池，例如仿制品、经过改造或其它品牌的蓄电池，有受伤的危险以及因为蓄电池爆炸而造成的财物损失。

进一步的安全规章和工作指示







- ▶ **含铅的颜料以及某些木材、矿物和金属的加工废尘有害健康。可能造成过敏、让操作者感染 呼吸道疾病和 / 或罹患癌症。** 只有经过专业训练的人员才能够加工含石棉的物料。
 - 工作场所要保持空气流通。
 - 最好佩戴 P2 滤网等级的口罩。
 请留心并遵守贵国和加工物料有关的法规。
- ▶ **避免让工作场所堆积过多的尘垢。** 尘埃容易被点燃。
- ▶ **维修电动工具、更换电动工具上的工具或者搬运电动工具时，务必把正逆转开关调整到中央的位置。** 如果不小启动起停开关，可能造成伤害。
- ▶ **交货时蓄电池只完成部分充电，为了确保能够发挥电池的最大功率，首度使用前必须把蓄电池放入充电器中充足电。**
- ▶ **蓄电池上安装了 NTC- 温度监控装置。** 当温度位在摄氏 0 ° C 到 45 ° C 度间时，才能进行充电。所以能够大大地延长蓄电池的使用寿命。
- ▶ **阅读充电器的使用说明书。**
- ▶ **确定电动工具已经关闭了，才可以把电动工具顶在螺丝头上。** 转动中的起子头容易从螺丝头上滑开。
- ▶ **待电动工具完全静止后才能够启动选档开关。**
- ▶ **必须把换挡开关推到底，也要将操作功能变换开关转到尽端。** 否则可能损坏电动工具。
- ▶ **当机器过度超荷时，例如安装在机器上的工具被卡住了，电子装备会关闭电动工具。重新开机之后又可以根掘用途继续操作电动工具。如果持续超荷，电动工具又会再度关机以免损坏马达。**

代表符号

以下的符号可以帮助您正确地使用本机器。请仔细阅读各符号及它们的代表意思。正确了解各符号所代表的意义，可以帮助您更有把握更安全地操作本机器。

符号	含义
	GSR 14,4 V-Li / GSR 18 V-Li / GSB 14,4 V-Li / GSB 18 V-Li: 充电式电钻起子机 / 充电式冲击钻起子机 打上灰色记号的部位：手柄（绝缘的握持位置）
	物品代码
	阅读所有的安全规章和说明
	在电动工具上进行任何维修的工作之前，都必须先取出蓄电池
	请佩戴耳罩
	移动方向
	反应方向
	钻击和拧转螺丝
	冲击钻
	低转速
	高转速
	开动
	关闭
	正 / 逆转功能
U	额定电压

10 | 中文

符号	含义
n_s	冲击次数
$n_0 1$	空转转速 (1 档)
$n_0 2$	空转转速 (2 档)
M	根据 ISO 5393 的最大扭力
	泥墙
	金属
	木材
\emptyset	最大钻孔直径
\emptyset 	最大螺丝直径
	夹头的夹紧范围
	重量符合 EPTA-Procedure 01:2014
*	视所使用的蓄电池而定

供货范围

充电式电钻起子机 / 充电式冲击电钻起子机。
蓄电池、安装在机器上的工具以及插图中或说明书中提到的附件，并不包含在标准的供货范围中。
在本公司的附件清单中标列了完整的附件。

按照规定使用机器

本电动工具适合拧入和拧松螺丝。并且可以在木材、金属、陶器和塑料上进行钻孔。另外 GSB 也可以在砖头、砌墙和石块上进行冲击钻。

技术数据

本产品的技术数据列在本使用说明书 33 页的表格中。
请认清电动工具铭牌上的物品代码。电动工具在销售市场上没有统一的商品名称。

安装和操作

执行目的	图片	页数
取出蓄电池	1	34
安装蓄电池	2	34
安装工具	3	34
改变转向	4	35
设定扭力	5	35
选择钻孔位置	6	36
设定操作模式	7	36
机械式选档	8	36
开动 / 关闭	9	37
选择附件	-	38

维修和清洁

► **电动工具和通风间隙都必须保持清洁，这样才能够提高工作品质和安全性。**

每次使用完毕后，都要清洁安装在机器上的工具，工具的接头，电动工具的通气孔以及蓄电池的通气孔。

顾客服务处和顾客咨询中心

本公司顾客服务处负责回答有关本公司产品的修理，维护和备件的问题。以下的网页中有爆炸图和备件的资料：
www.bosch-pt.com

博世顾客咨询团队非常乐意为您解答有关本公司产品及附件的问题。

询问和订购备件时，务必提供机器铭牌上标示的 10 位数物品代码。

有关保证，维修或更换零件事宜，请向合格的经销商查询。

中国大陆

博世电动工具（中国）有限公司
中国 浙江省 杭州市
滨江区滨康路 567 号
邮政编码：310052
免费服务热线：4008268484
传真：(0571) 87774502
电邮：contact.ptcn@cn.bosch.com
www.bosch-pt.com.cn

羅伯特·博世有限公司
香港北角英皇道 625 號 21 樓
客戶服務熱線：+852 2101 0235
傳真：+852 2590 9762
電郵：info@hk.bosch.com
網站：www.bosch-pt.com.hk

制造商地址：

Robert Bosch Power Tools GmbH
 罗伯特·博世电动工具有限公司
 70538 Stuttgart / GERMANY
 70538 斯图加特 / 德国

搬运

随着机器一起供货的锂离子蓄电池必须受危险物品法规规范。使用者无须另外使用保护包装便可以运送该蓄电池。

但是如果将它交由第三者运送（例如：寄空运或委托运输公司）则要使用特殊的包装和标示。此时必须向危险物品专家请教有关寄送危险物品的相关事宜。

确定蓄电池的外壳未受损后，才可以寄送蓄电池。粘好未加盖的触点并包装好蓄电池，不可以让蓄电池在包装中晃动。

必要时也得注意各国有关的法规。

处理废弃物

必须以符合环保的方式，回收再利用损坏的电动工具、蓄电池、附件和废弃的包装材料。

不可以把电动工具和蓄电池 / 电池丢入一般的家庭垃圾中！

充电电池 / 电池：

锂离子：
 请注意“搬运”段落中的指示，
 页 11。

保留修改权。

中文**電動工具通用安全警告**

警告 閱讀所有警告和所有說明。不遵照以下警告和說明會導致電擊、著火和 / 或嚴重傷害。

保存所有警告和說明書以備查閱。

在所有下列的警告中術語“電動工具”指市電驅動（有線）電動工具或電池驅動（無線）電動工具。

工作場地的安全

▶ 保持工作場地清潔和明亮。混亂和黑暗的場地會引發事故。

▶ 不要在易爆環境，如有易燃液體、氣體或粉塵的環境下操作電動工具。電動工具產生的火花會點燃粉塵或氣體。

▶ 讓兒童和旁觀者離開後操作電動工具。注意力不集中會使你失去對工具的控制。

電氣安全

▶ 電動工具插頭必須與插座相配。絕不能以任何方式改裝插頭。需接地的電動工具不能使用任何轉換插頭。未經改裝的插頭和相配的插座將減少電擊危險。

▶ 避免人體接觸接地表面，如管道、散熱片和冰箱。如果你身體接地會增加電擊危險。

▶ 不得將電動工具暴露在雨中或潮濕環境中。水進入電動工具將增加電擊危險。

▶ 不得濫用電線。絕不能用電線搬運、拉動電動工具或拔出其插頭。使電線遠離熱源、油、銳邊或運動部件。受損或纏繞的軟線會增加電擊危險。

▶ 當在戶外使用電動工具時，使用適合戶外使用的外接軟線。適合戶外使用的軟線，將減少電擊危險。

▶ 如果在潮濕環境下操作電動工具是不可避免的，應使用剩餘電流動作保護器（RCD）。使用 RCD 可減小電擊危險。

人身安全

▶ 保持警覺，當操作電動工具時關注所從事的操作並保持清醒。當你感到疲倦，或在有藥物、酒精或治療反應時，不要操作電動工具。在操作電動工具時瞬間的疏忽會導致嚴重人身傷害。

▶ 使用個人防護裝置。始終佩戴護目鏡。安全裝置，諸如適當條件下使用防塵面具、防滑安全鞋、安全帽、聽力防護等裝置能減少人身傷害。

▶ 防止意外起動。確保開關在連接電源和 / 或電池盒、拿起或搬運工具時處於關斷位置。手指放在已接通電源的開關上或開關處於接通時插入插頭可能會導致危險。

▶ 在電動工具接通之前，拿掉所有調節鑰匙或扳手。遺留在電動工具旋轉零件上的扳手或鑰匙會導致人身傷害。

▶ 手不要伸展得太長。時刻注意立足點和身體平衡。這樣在意外情況下能很好地控制電動工具。

▶ 著裝適當。不要穿寬鬆衣服或佩戴飾品。讓你的衣服、手套和頭髮遠離運動部件。寬鬆衣服、佩飾或長髮可能會捲入運動部件中。

▶ 如果提供了與排屑、集塵設備連接用的裝置，要確保他們連接完好且使用得當。使用這些裝置可減少塵屑引起的危險。

電動工具使用和注意事項

▶ 不要濫用電動工具，根據用途使用適當的電動工具。選用適當設計的電動工具會使你工作更有效、更安全。

12 | 中文

- ▶ 如果開關不能接通或關斷工具電源，則不能使用該電動工具。不能用開關來控制的電動工具是危險的且必須進行修理。
- ▶ 在進行任何調節、更換附件或貯存電動工具之前，必須從電源上拔掉插頭和/或使電池盒與工具脫開。這種防護性措施將減少工具意外起動的危險。
- ▶ 將閒置不用的電動工具貯存在兒童所及範圍之外，並且不要讓不熟悉電動工具或對這些說明不瞭解的人操作電動工具。電動工具在未經培訓的用戶手中是危險的。
- ▶ 保養電動工具。檢查運動件是否調整到位或卡住，檢查零件破損情況和影響電動工具運行的其他狀況。如有損壞，電動工具應在使用前修理好。許多事故由維護不良的電動工具引發。
- ▶ 保持切削刀具鋒利和清潔。保養良好的有鋒利切削刃的刀具不易卡住而且容易控制。
- ▶ 按照使用說明書，考慮作業條件和進行的作業來使用電動工具、附件和工具的刀頭等。將電動工具用於那些與其用途不符的操作可能會導致危險。

電池式工具使用和注意事項

- ▶ 只用製造商規定的充電器充電。將適用於某種電池盒的充電器用到其他電池盒時會發生著火危險。
- ▶ 只有在配有專用電池盒的情況下才使用電動工具。使用其他電池盒會發生損壞和著火危險。
- ▶ 當電池盒不用時，將它遠離其他金屬物體，例如回形針、硬幣、鑰匙、釘子、螺釘或其他小金屬物體，以防一端與另一端連接。電池端部短路會引起燃燒或火災。
- ▶ 在濫用條件下，液體會從電池中濺出；避免接觸。如果意外碰到了，用水沖洗。如果液體碰到了眼睛，還要尋求醫療幫助。從電池中濺出的液體會發生腐蝕或燃燒。

檢修

- ▶ 將你的電動工具送交專業維修人員，必須使用同樣的備件進行更換。這樣將確保所維修的電動工具的安全性。

針對電鑽和電動扳手的安全規章

GSB 14,4 V-LI / GSB 18 V-LI

- ▶ 使用衝擊電鑽時要戴好耳罩。暴露在噪音中會引起聽力損傷。

GSR 14,4 V-LI / GSR 18 V-LI /

GSB 14,4 V-LI / GSB 18 V-LI

- ▶ 安裝在機器上的工具或螺絲如果可能割斷隱藏的電線，一定要按住絕緣手柄操作電動工具。電動工具如果割斷了帶電的電線，機器上的金屬部件會導電，並進而導致操作者觸電。

- ▶ 如果電動工具提供了輔助手柄便要使用它。操作時失控可能導致傷害。
- ▶ 使用合適的偵測器，以便找出隱藏著的電源線的位置。或者向當地的供電單位索取相關資料。鑽穿電線會造成火災並遭受電擊。損壞瓦斯管會引起爆炸。如果水管被刺穿了會導致財物損失。
- ▶ 如果安裝在機器上的工具被夾住了，必須馬上關閉電動工具並保持鎮靜。此時機器會產生極高的反應力矩，並進而造成回擊。安裝在機器上的工具容易被夾住如果：
 - 電動工具超荷了，或者
 - 安裝在機器上的工具在工件中歪斜了。
- ▶ 務必握緊電動工具。在擰緊和放鬆螺絲時，可能出現短暫的強大反擊。
- ▶ 固定好工件。使用固定裝置或老虎鉗固定工件，會比用手持握工件更牢固。
- ▶ 工作場所必須保持清潔。不同的工作塵經過混合後容易產生化學反應，十分危險。輕金屬塵容易著火或引起爆炸。
- ▶ 切勿打開蓄電池。可能造成短路。



保護蓄電池免受高溫（例如長期日照），火焰，水和濕氣的侵害。有爆炸的危險。



- ▶ 如果蓄電池損壞了，或者未按照規定使用蓄電池，蓄電池中會散發出有毒蒸汽。工作場所必須保持空氣流通，如果身體有任何不適必須馬上就醫。蓄電池散發的蒸汽會刺激呼吸道。
- ▶ 本蓄電池只能配合博世的電動工具一起使用。這樣才能確保蓄電池不會過載。
- ▶ 只能使用博世原廠的蓄電池。電池的電壓必須和電動工具銘牌上規定的電壓相符。使用其他的蓄電池，例如仿制品，經過改造或其它品牌的蓄電池，有受傷的危險以及因為蓄電池爆炸而造成的財物損失。

進一步的安全規章和工作指示

- ▶ 含鉛的顏料以及某些木材、礦物和金屬的加工廢塵有害健康、可能造成過敏、讓操作者感染呼吸道疾病和/或癌症。只有經過專業訓練的人員才能夠加工含石棉的物料。
 - 工作場所要保持空氣流通。
 - 最好佩戴 P2 濾網等級的口罩。
 請留心並遵守貴國和加工物料有關的法規。
- ▶ 避免讓工作場所堆積過多的塵垢。塵埃容易被點燃。
- ▶ 維修電動工具、更換電動工具上的工具或者搬運電動工具時，務必把正逆轉開關調整到中央的位置。如果不小心啟動起停開關，可能造成傷害。
- ▶ 交貨時蓄電池只完成部分充電，為了確保能夠發揮電池的最大功率，首度使用前必須把蓄電池放入充電器中充足電。

- ▶ 蓄電池上安裝了 NTC- 溫度監控裝置。當溫度位在攝氏 0 °C 到 45 °C 間時，才能進行充電。所以能夠大大地延長蓄電池的使用壽命。
- ▶ 閱讀充電器的使用說明書。
- ▶ 確定電動工具已經關閉了，才可以把電動工具頂在螺絲頭上。轉動中的起子頭容易從螺絲頭上滑開。
- ▶ 待電動工具完全靜止後才能夠啟動選檔開關。
- ▶ 必須把換檔開關推到底，也要將操作功能變換開關轉到盡端。否則可能損壞電動工具。
- ▶ 當機器過度超荷時，例如安裝在機器上的工具被卡住了，電子裝置會關閉電動工具。重新開機之後又可以根據用途繼續操作電動工具。如果持續超荷，電動工具又會再度關機以免損壞馬達。

代表符號

以下的符號可以幫助您正確地使用本機器。請詳細閱讀各符號及它們的代表意思。正確了解各符號所代表的意義，可以幫助您更有把握更安全地操作本機器。

符號	含義
	GSR 14,4 V-Li / GSR 18 V-Li / GSB 14,4 V-Li / GSB 18 V-Li: 充電式電鑽起子機 / 充電式沖擊鑽起子機 打上灰色記號的部位：手柄（絕緣的握持位置）
	物品代碼
	閱讀所有的安全規章和說明
	在電動工具上進行任何維修的工作之前，都必須先取出蓄電池
	請佩戴耳罩
	移動方向
	反應方向
	鑽擊和擰轉螺絲

符號	含義
	沖擊鑽
	低轉速
	高轉速
	開動
	關閉
	正 / 逆轉功能
U	額定電壓
n _s	沖擊次數
n _{0 1}	空轉轉速（1 檔）
n _{0 2}	空轉轉速（2 檔）
M	根據 ISO 5393 的最大扭力
	磚牆
	金屬
	木材
∅	最大鑽孔直徑
	最大螺絲直徑
	夾頭的夾緊範圍
	重量符合 EPTA-Procedure 01:2014
*	視所使用的蓄電池而定

供貨範圍

充電式電鑽起子機 / 充電式衝擊電鑽起子機。
蓄電池、安裝在機器上的工具以及插圖中或說明書中提到的附件，並不包含在標準的供貨範圍中。
在本公司的附件清單中標列了完整的附件。

按照規定使用機器

本電動工具適合擰入和擰松螺絲。並且可以在木材、金屬、陶瓷和塑料上進行鑽孔。另外 GSB 也可以在磚頭、砌牆和石塊上進行沖擊鑽。

技術性數據

本產品的技術數據列在本使用說明書 33 頁的表格中。
請認清電動工具銘牌上的物品代碼。電動工具在銷售市場上沒有統一的商品名稱。

14 | 한국어

安裝和操作

執行目的	圖片	頁數
取出蓄電池	1	34
安裝蓄電池	2	34
安裝工具	3	34
改變轉向	4	35
設定扭力	5	35
選擇鑽孔位置	6	36
設定操作模式	7	36
機械式選檔	8	36
開動 / 關閉	9	37
選擇附件	-	38

維修和清潔

▶ **電動工具和通風間隙都必須保持清潔，這樣才能夠提高工作品質和安全性。**

每次使用完畢後，都要清潔安裝在機器上的工具，工具的接頭，電動工具的通氣孔以及蓄電池的通氣孔。

顧客服務處和顧客諮詢中心

本公司顧客服務處負責回答有關本公司產品的修理，維護和備件的問題。以下的網頁中有爆炸圖和備件的資料：

www.bosch-pt.com

博世顧客諮詢團隊非常樂意為您解答有關本公司產品及附件的問題。

詢問和訂購備件時，務必提供機器銘牌上標示的 10 位數物品代碼。

台灣

台灣羅伯特博世股份有限公司

建國北路一段 90 號 6 樓

台北市 10491

電話：(02) 2515 5388

傳真：(02) 2516 1176

www.bosch-pt.com.tw

制造商地址：

Robert Bosch Power Tools GmbH

羅伯特·博世電動工具有限公司

70538 Stuttgart / GERMANY

70538 斯圖加特 / 德國

搬運

隨著機器一起供貨的鋰離子蓄電池必須受危險物品法規範。使用者無須另外使用保護包裝便可以運送該蓄電池。

但是如果將它交由第三者運送（例如：寄空運或委託運輸公司）則要使用特殊的包裝和標示。此時必須向危險物品專家請教有關寄送危險物品的相關事宜。

確定蓄電池的外殼未受損後，才可以寄送蓄電池。粘好未加蓋的觸點並包裝好蓄電池，不可以讓蓄電池在包裝中晃動。

必要時也得注意各國有關的法規。

處理廢棄物

 必須以符合環保的方式，回收再利用損壞的電動工具，蓄電池，附件和廢棄的包裝材料。

不可以把電動工具和蓄電池 / 電池丟入一般的家庭垃圾中！

蓄電池 / 一般電池：



鋰離子：

請注意 "搬運" 段落中的指示，頁 14。

保留修改權。

한국어

전동공구용 일반 안전수칙

⚠ 경고 모든 안전수칙과 지시 사항을 상세히 읽고 지켜야 합니다. 다음의 안전수칙과 지시 사항을 준수하지 않으면 화재 위험이 있으며 감전 혹은 중상을 입을 수 있습니다.

앞으로의 참고를 위해 이 안전수칙과 사용 설명서를 잘 보관하십시오.

다음에서 사용되는 "전동공구" 라는 개념은 전원에 연결하여 사용하는 전동 기기 (전선이 있는) 나 배터리를 사용하는 전동 기기 (전선이 없는) 를 의미합니다.

작업장 안전

- ▶ **작업장을 항상 깨끗이 하고 조명을 밝게 하십시오.** 작업장 환경이 어수선하거나 어두우면 사고를 초래할 수 있습니다.
- ▶ **가연성 유체, 가스 또는 분진이 있어 폭발 위험이 있는 환경에서 전동공구를 사용하지 마십시오.** 전동공구는 분진이나 증기에 점화하는 스파크를 일으킬 수 있습니다.
- ▶ **전동공구를 사용할 때 구경꾼이나 어린이 혹은 다른 사람이 작업장에 접근하지 못하게 하십시오.** 다른 사람이 주의를 산만하게 하면 기기에 대한 통제를 잃기 쉽습니다.

전기에 관한 안전

- ▶ **전동공구의 전원 플러그가 전원 콘센트에 잘 맞아야 합니다.** 플러그를 조금이라도 변경시켜서는 안됩니다. 접지된 전동공구를 사용할 때 어댑터 플러그를 사용하지 마십시오. 변형되지 않은 플러그와 잘 맞는 콘센트를 사용하면 감전의 위험을 감소할 수 있습니다.
- ▶ **파이프 관, 라디에이터, 레인지, 냉방고와 같은 접지 표면에 몸이 닿지 않도록 하십시오.** 몸에 닿을 경우 감전될 위험이 높습니다.
- ▶ **전동공구를 비에 맞지 않게 하고 습기 있는 곳에 두지 마십시오.** 전동공구에 물이 들어가면 감전될 위험이 높습니다.
- ▶ **전원 코드를 잡고 전동공구를 운반하거나 걸어 놓아서는 안되며, 콘센트에서 전원 플러그를 뽑을 때 전원 코드를 잡아 당겨서는 절대로 안됩니다.** 전원 코드가 열과 오일에 접촉하는 것을 피하고, 날카로운 모서리나 기기의 가동 부위에 닿지 않도록 주의하십시오. 손상되거나 엉킨 전원 코드는 감전을 유발할 수 있습니다.
- ▶ **실외에서 전동공구로 작업할 때는 실외용으로 적당한 연장 전원 코드만을 사용하십시오.** 실외용 연장 전원 코드를 사용하면 감전의 위험을 줄일 수 있습니다.
- ▶ **전동공구를 습기 찬 곳에서 사용해야 할 경우에는 누전 차단기를 사용하십시오.** 누전 차단기를 사용하면 감전 위험을 줄일 수 있습니다.

사용자 안전

- ▶ **신중하게 작업하십시오.** 작업을 할 때 주의를 하며, 전동공구를 사용할 때 경솔하게 행동하지 마십시오. 피로한 상태이거나 약물 복용 및 음주한 후에는 전동공구를 사용하지 마십시오. 전동공구를 사용할 때 잠이라도 주의가 산만해지면 중상을 입을 수 있습니다.
- ▶ **작업자 안전을 위한 장치를 사용하십시오.** 항상 보안경을 착용하십시오. 전동공구의 종류와 사용에 따라 먼지 보호 마스크, 미끄러지지 않는 안전한 신발, 안전모 또는 귀마개 등의 안전한 복장을 하면 상해의 위험을 줄일 수 있습니다.
- ▶ **실수로 기기가 작동되지 않도록 주의하십시오.** 전동공구를 전원에 연결하거나 배터리를 끼우기 전에, 혹은 기기를 들거나 운반하기 전에, 전원 스위치가 꺼져 있

는지 다시 확인하십시오. 전동공구를 운반할 때 전원 스위치에 손가락을 대거나 전원 스위치가 켜진 상태에서 전원을 연결하면 사고 위험이 높습니다.

- ▶ **전동공구를 사용하기 전에 조절하는 톨이나 나사 키 등을 빼 놓으십시오.** 회전하는 부위에 있는 톨이나 나사 키로 인해 상처를 입을 수 있습니다.
- ▶ **자신을 과신하지 마십시오.** 불안정한 자세를 피하고 항상 평형을 이룬 상태로 작업하십시오. 안정된 자세와 평형한 상태로 작업해야만이 의외의 상황에서도 전동공구를 안전하게 사용할 수 있습니다.
- ▶ **알맞은 작업복을 입으십시오.** 헐렁한 복장을 하거나 장신구를 착용하지 마십시오. 머리카락 또는 장갑이 가동하는 기기 부위에 가까이 닿지 않도록 주의하십시오. 헐렁한 복장, 장신구 혹은 긴 머리는 가동 부위에 말려 사고를 초래할 수 있습니다.
- ▶ **분진 추출장치나 수거장치의 조립이 가능한 경우, 이 장치가 연결되어 있는지, 제대로 작동이 되는지 확인하십시오.** 이러한 분진 추출장치를 사용하면 분진으로 인한 사고 위험을 줄일 수 있습니다.

전동공구의 올바른 사용과 취급

- ▶ **기기를 과부하 상태에서 사용하지 마십시오.** 작업할 때 이에 적당한 전동공구를 사용하십시오. 알맞은 전동공구를 사용하면 지정된 성능 한도 내에서 더 효율적으로 안전하게 작업할 수 있습니다.
- ▶ **전원 스위치가 고장 난 전동공구를 사용하지 마십시오.** 전원 스위치가 작동되지 않는 전동공구는 위험하므로, 반드시 수리를 해야 합니다.
- ▶ **기기에 세팅을 하거나 액세서리 부품을 교환하거나 혹은 기기를 보관할 때, 항상 전원 콘센트에서 플러그를 미리 빼어 놓으십시오.** 이러한 조치는 실수로 전동공구가 작동하게 되는 것을 예방합니다.
- ▶ **사용하지 않는 전동공구는 어린이 손이 닿지 않는 곳에 보관하고, 전동공구 사용에 익숙지 않거나 이 사용 설명서를 읽지 않은 사람은 기기를 사용해서는 안됩니다.** 경험이 없는 사람이 전동공구를 사용하면 위험합니다.
- ▶ **전동공구를 조심스럽게 관리하십시오.** 가동 부위가 혼자 없이 정상적인 기능을 하는지, 걸리는 부위가 있는지, 혹은 전동공구의 기능에 중요한 부품이 손상되지 않았는지 확인하십시오. 손상된 기기의 부품은 전동공구를 다시 사용하기 전에 반드시 수리를 맡기십시오. 제대로 관리하지 않은 전동공구의 경우 많은 사고를 유발합니다.
- ▶ **절단 공구를 날카롭고 깨끗하게 관리하십시오.** 날카로운 절단면이 있고 잘 관리된 절단공구는 걸리는 경우가 드물고 조절하기도 쉽습니다.
- ▶ **전동공구, 액세서리, 장착하는 공구 등을 사용할 때, 이 지시 사항과 특별히 기종 별로 나와있는 사용 방법을 준수하십시오.** 이때 작업 조건과 실시하려는 작업 내용을 고려하십시오. 원래 사용 분야가 아닌 다른 작업에 전동공구를 사용할 경우 위험한 상황을 초래할 수 있습니다.

16 | 한국어

충전 전동공구의 올바른 사용과 취급

- ▶ 배터리를 충전할 때 제조 회사가 추천하는 충전기만을 사용하여 재충전해야 합니다. 특정 제품의 배터리를 위하여 제조된 충전기에 적합하지 않은 다른 배터리를 충전할 경우 화재 위험이 있습니다.
- ▶ 각 전동공구용으로 나와있는 배터리만을 사용하십시오. 다른 종류의 배터리를 사용하면 상해를 입거나 화재를 초래할 수 있습니다.
- ▶ 배터리를 사용하지 않을 때는, 각 극 사이에 브리징 상태가 생길 수 있으므로 페이퍼 클립, 동전, 열쇠, 못, 나사 등 유사한 금속성 물체를 멀리하여 보관하십시오. 배터리 극 사이에 쇼트가 일어나 화상을 입거나 화재를 야기할 수 있습니다.
- ▶ 배터리를 잘못 사용하면 누수가 생길 수 있습니다. 누수가 생긴 배터리에 닿지 않도록 하십시오. 피부에 접하게 되었을 경우 즉시 물로 씻으십시오. 유체가 눈에 닿았을 경우 바로 의사와 상담하십시오. 배터리에서 나오는 유체는 피부에 자극을 주거나 화상을 입힐 수 있습니다.

서비스

- ▶ 전동공구 수리는 반드시 전문 인력에게 맡기고, 수리 정비 시 보쉬 순정 부품만을 사용하십시오. 그렇게 함으로써 기기의 안전성을 오래 유지할 수 있습니다.

드릴 머신과 스크류 드라이버용 안전 수칙

GSB 14,4 V-LI/GSB 18 V-LI

- ▶ 임팩트 드릴작업을 할 때 귀마개를 착용하십시오. 소음으로 인해 청각을 상실할 수 있습니다.

**GSR 14,4 V-LI/GSR 18 V-LI/
GSB 14,4 V-LI/GSB 18 V-LI**

- ▶ 작업할 때 드릴 비트나 나사로 보이지 않는 전선에 닿을 가능성이 있으면 전동공구의 절연 손잡이면을 잡으십시오. 전류가 흐르는 전선에 접하게 되면 전동공구의 금속 부위도 전기가 통해 감전이 될 수 있습니다.
- ▶ 보조 손잡이가 전동공구와 함께 공급되는 경우 이를 사용하십시오. 통제를 잃게 되면 상해를 입을 수 있습니다.
- ▶ 보이지 않는 부위에 에너지 배선 및 배관여부를 확인하려면 적당한 탐지기를 사용하거나 담당 에너지 공급 회사에 문의하십시오. 전선에 접촉하게 되면 화재나 전기 충격을 유발할 수 있습니다. 가스관을 손상시키면 폭발 위험이 있으며 수도관을 파손하게 되면 재산 피해를 야기할 수 있습니다.
- ▶ 톨 홀더에 끼워진 비트가 돌리면 즉시 전동공구 스위치를 끄십시오. 반동을 유발할 수 있는 강한 반동력이 생길 수 있습니다. 톨 홀더에 끼워진 비트는 다음의 경우 물립니다:

- 전동공구가 과부하된 상태이거나
- 작업하려는 소재에 걸렸을 경우 물립니다.

- ▶ 전동공구를 꼭 잡으십시오. 나사못을 조이거나 풀 때 일시적으로 강한 반동력이 생길 수 있습니다.
- ▶ 작업물을 잘 고정하십시오. 고정장치나 기계 바이스에 끼워서 작업하면 손으로 잡는 것보다 더 안전합니다.
- ▶ 작업장을 항상 깨끗이 유지하십시오. 작업 소재의 혼합물은 특히 위험합니다. 경금속 분진은 화재나 폭발을 야기할 수 있습니다.
- ▶ 배터리를 분해하지 마십시오. 단락이 발생할 위험이 있습니다.



배터리를 태양 광선 등 고열에 장시간 노출되지 않도록 하고 불과 물, 수분이 있는 곳에 두지 마십시오. 폭발할 위험이 있습니다.



- ▶ 배터리가 손상되었거나 잘못 사용될 경우 증기가 발생할 수 있습니다. 작업장을 환기시키고, 필요한 경우 의사와 상담하십시오. 증기로 인해 호흡기가 자극될 수 있습니다.
- ▶ 배터리를 보쉬 전동공구와 함께 사용해야 합니다. 그렇게 해야만 배터리를 위험한 과부하로부터 보호할 수 있습니다.
- ▶ 전동공구의 타입 표시판에 나와있는 전압에 해당하는 보쉬 순정 배터리만을 사용하십시오. 모조품이나 재생 복원 배터리 혹은 타사의 배터리를 사용하면 폭발성이 있는 배터리로 인해 상해를 입을 수 있으며 물적 손해를 볼 수 있습니다.







기타 안전수칙 및 사용방법



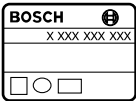









- ▶ 납 성분을 함유한 페인트나 몇몇 목재 종류, 광물 및 금속 등 소재의 분진은 건강에 유해할 수 있으며 알레르기 반응이나 호흡기 질환 그리고 / 혹은 암을 유발할 수 있습니다. 석면을 함유한 소재는 위험하므로 전문 인력들만이 작업해야 합니다.
 - 작업장의 통풍이 잘 되도록 하십시오.
 - 필터등급 P2가 장착된 호흡 마스크를 사용하십시오.
 작업용 재료에 관해 국가가 지정한 규정을 고려 하십시오.
- ▶ 작업장에 분진이 쌓이지 않도록 하십시오. 분진이 쉽게 발화할 수 있습니다.
- ▶ 전동공구에 정비를 하거나 비트 등을 교환하기 전에, 혹은 기기를 운반하거나 보관할 때 회전방향 선택 스위치를 반드시 중간 위치에 두십시오. 실수로 전원 스위치가 작동하여 상해를 입을 수 있습니다.
- ▶ 배터리는 일부 충전된 상태로 공급됩니다. 배터리의 완전한 성능을 보장하려면 처음 사용하기 전에 배터리를 완전히 충전해야 합니다.
- ▶ 배터리에는 NTC 온도 모니터가 내장되어 있어, 섭씨 0 ° C에서 45 ° C의 온도 범위에서만 충전이 가능합니다. 이렇게 함으로써 배터리의 수명이 연장됩니다.

- ▶ 충전기의 사용 설명서를 읽으십시오.
- ▶ 전동공구의 스위치가 꺼진 상태에서만 나사못에 대십시오. 회전하는 드릴 비트가 미끄러질 수 있습니다.
- ▶ 기어 선택 스위치는 전동공구가 정지된 상태에서만 작동하십시오.
- ▶ 기어 선택 스위치를 밀거나 작동모드 선택 스위치를 돌릴 때 항상 끝까지 가도록 하십시오. 그렇지 않으면 전동공구가 손상될 수 있습니다.
- ▶ 드릴 비트가 오랫동안 걸려 움직이지 않는 등 과도한 부하 상태의 경우가 되면 전동공구의 전자장치 저절로 꺼집니다. 전동공구의 스위치를 켜면 다시 사용 규정으로 사용할 수 있습니다. 과부하 상태가 지속되면 모터가 손상되는 것을 방지하기 위해 전동공구가 다시 꺼집니다.

기호

다음에 나와있는 기호는 사용 설명서를 읽고 이해하는데 중요합니다. 그러므로 기호와 그 의미를 잘 기억하십시오. 기호를 제대로 이해하면 전동공구를 더욱 쉽고 안전하게 사용할 수 있습니다.

기호	의미
	GSR 14,4 V-Li/GSR 18 V-Li/ GSB 14,4 V-Li/GSB 18 V-Li: 충전 드라이버 드릴/충전 해머 드릴 회색 표시 부위: 손잡이 (절연 손잡이)
	제품 번호 x xxx xxx xxx
	모든 안전 수칙과 지시 사항을 읽으십시오
	전동공구에 각종 작업을 하기 전에 배터리를 빼어 놓으십시오
	귀마개를 착용하십시오
	이동 방향
	반동 방향
	드릴 및 스크류작업

기호	의미
	임팩트 드릴작업
	저속
	고속
	스위치 켜기
	스위치 끄기
	역회전 기능
U	정격 전압
n _s	타격률
n _{0 1}	무부하 속도 (1 단)
n _{0 2}	무부하 속도 (2 단)
M	ISO 5393 에 따른 최대 토크
	벽돌
	금속
	목재
∅	최대 드릴 직경
	나사못 직경, 최대
	드릴 척 클램핑 범위
	EPTA 공정 01:2014 에 따른 중량
*	사용하는 배터리에 따라 상이.

공급 내역

충전 드라이버 드릴/충전 해머 드릴.
배터리와 삽입 비트 및 도면이나 설명서에 나와있는 기타 액세서리는 표준 공급 부품에 속하지 않습니다.
전체 액세서리는 본사 액세서리 프로그램을 참고하십시오.

규정에 따른 사용

본 전동공구는 목재 금속 세라믹 플라스틱 등에 나사못을 조이거나 푸는 작업과 구멍을 내는 작업을 하는데 사용해야 합니다. GSB 모델을 사용하면 또한 벽돌 콘크리트 석재에 임팩트 드릴작업도 가능합니다.

제품 사양

제품의 제품 사양은 본 사용 설명서의 33 면의 도표에 나와 있습니다.

전동공구의 명판에 표시된 제품 번호를 확인하십시오. 각 전동공구의 명칭이 시중에서 상이하게 사용될 수 있습니다.

18 | ภาษาไทย

조립 및 작동

작업 내용	그림	면
배터리 탈착하기	1	34
배터리 장착하기	2	34
삽입공구 조립하기	3	34
회전방향 설정하기	4	35
토크 설정하기	5	35
드릴 위치선택하기	6	36
작동 모드 설정하기	7	36
기계식 기어 선택	8	36
전원 스위치 작동하기	9	37
액세서리 선택하기	-	38

보수 정비 및 유지

▶ **안전하고 올바른 작동을 위하여 전동공구와 전동공구의 통풍구를 항상 깨끗이 하십시오.**

전동공구를 사용하고 나서 매번 드릴 비트, 톨 홀더, 전동공구의 통풍구 및 배터리의 통풍구를 깨끗이 닦아 주십시오.

보쉬 AS 및 고객 상담

보쉬는 귀하의 제품 및 수리에 관한 문의를 받고 있습니다.

AS 센터 정보 및 제품에 대한 고객 상담은 하기 고객 콜센터 및 이메일 상담을 이용하십시오.

고객 콜센터 : 080-955-0909

이메일 상담 :

Bosch-pt.hotline@kr.bosch.com

문의 사항이 있거나 스페어 부품을 주문할 때 반드시 전동공구의 타입 표시판에 적힌 10 자리의 제품 번호를 알려 주십시오.

한국로버트보쉬 (주)

경기도 용인시 기흥구 보정동 298 번지

www.bosch-pt.co.kr

운반

포함되어 있는 리튬이온 배터리는 위험물 관련 규정을 따라야 합니다. 사용자가 별도의 요구사항 없이 배터리를 직접 도로 상에서 운반할 수 있습니다.

제 3 자를 통해 운반할 경우 (항공 운송이나 운송 회사 등) 포장과 표기에 관한 특별한 요구 사항을 준수해야 합니다. 이 경우 발송 준비를 위해 위험물 전문가와 상담해야 합니다.

표면이 손상되지 않은 배터리만을 사용하십시오. 배터리의 접촉 단자면을 덮어 붙인 상태로 내부에서 움직이지 않도록 배터리를 포장하십시오.

또한 이와 관련한 국내 규정을 준수하십시오.

처리

 전동공구, 배터리, 액세서리 및 포장은 친환경적인 방법으로 재활용할 수 있도록 분류하십시오.

전동공구와 충전용 배터리 / 배터리를 가정용 쓰레기로 처리하지 마십시오!

충전용 배터리 / 배터리 :



Li-Ion:
"운반" 내용에 나와 있는 주의 사항을 준수하십시오, 18 면.

위 사항은 사전 예고 없이 변경될 수도 있습니다.

ภาษาไทย

คำเตือนทั่วไปเพื่อความปลอดภัยในการใช้เครื่องมือไฟฟ้า

คำเตือน ต้องอ่านคำเตือนเพื่อความปลอดภัยและคำสั่งทั้งหมด การไม่ปฏิบัติตามคำเตือนและคำสั่งอาจเป็นสาเหตุให้ถูกไฟฟ้าดูด เกิดไฟไหม้ และ/หรือได้รับบาดเจ็บอย่างร้ายแรง

เก็บรักษาคำเตือนและคำสั่งทั้งหมดสำหรับเปิดอ่านในภายหลัง

คำว่า "เครื่องมือไฟฟ้า" ในคำเตือนหมายถึง เครื่องมือไฟฟ้าของท่านที่ทำงานด้วยพลังงานไฟฟ้าที่ต่อจากเต้าเสียบ (มีสายไฟฟ้า) และเครื่องมือไฟฟ้าที่ทำงานด้วยพลังงานไฟฟ้าจากแบตเตอรี่ (ไร้สาย)

ความปลอดภัยในสถานที่ทำงาน

▶ **รักษาสถานที่ทำงานให้สะอาดและมีไฟส่องสว่างดี**
สถานที่ที่มีมืดหรือรกยุ่งร้งนำมาซึ่งอุบัติเหตุ

- ▶ **อย่าใช้เครื่องมือไฟฟ้าในสภาพแวดล้อมที่เสี่ยงต่อการติดระเบิดได้ เช่น ในที่มีขงเพลิงเหลว แก๊ส หรือฝุ่นที่ติดไฟได้** เมื่อใช้เครื่องมือไฟฟ้าจะเกิดประกายไฟซึ่งอาจจุดฝุ่นหรือไอให้ลุกเป็นไฟได้
- ▶ **ขณะใช้เครื่องมือไฟฟ้าทำงาน ต้องกันเด็กและผู้ยืนดูให้ออกห่าง** การหันเหความสนใจอาจทำให้ท่านขาดการควบคุมเครื่องได้

ความปลอดภัยเกี่ยวกับไฟฟ้า

- ▶ **ปลั๊กของเครื่องมือไฟฟ้าต้องมีขนาดพอดีกับเต้าเสียบ อย่าตัดแปลงหรือแก้ไขตัวปลั๊กอย่างเด็ดขาด** อย่าต่อปลั๊กต่อกันเข้ากับเครื่องมือไฟฟ้าที่มีสายดิน ปลั๊กที่ไม่ตัดแปลงและเต้าเสียบที่เข้ากันช่วยลดความเสี่ยงจากการถูกไฟฟ้าดูด
- ▶ **หลีกเลี่ยงไม่ให้ร่างกายสัมผัสกับพื้นผิวของสิ่งของที่ต่อสายดินไว้ เช่น ท่อ เครื่องทำความร้อน เตา และตู้เย็น** จะเสี่ยงอันตรายจากการถูกไฟฟ้าดูดมากขึ้นหากกระแสไฟฟ้าวิ่งผ่านร่างกายของท่านลงดิน
- ▶ **อย่าวางเครื่องมือไฟฟ้าตากฝนหรือทิ้งไว้ในที่ชื้นแฉะ** หากน้ำเข้าในเครื่องมือไฟฟ้า จะเพิ่มความเสี่ยงจากการถูกไฟฟ้าดูด
- ▶ **อย่าใช้สายไฟฟ้าอย่างผิดๆ** อย่าถือเครื่องมือไฟฟ้าที่สาย อย่าใช้สายแขวนเครื่อง หรือยัดสายไฟฟ้าเพื่อถอดปลั๊กออกจากเต้าเสียบ กันสายไฟพ้ออกห่างจากความร้อน น้ำมัน ขอบแหลมคม หรือส่วนของเครื่องที่กำลังเคลื่อนไหว สายไฟฟ้าที่ชำรุดหรือพันกันยุ่งเพิ่มความเสี่ยงจากการถูกไฟฟ้าดูด
- ▶ **เมื่อใช้เครื่องมือไฟฟ้าทำงานกลางแจ้ง ให้ใช้สายไฟต่อที่ได้รับการรับรองให้ใช้ต่อในที่กลางแจ้งเท่านั้น** การใช้สายไฟต่อที่เหมาะสมสำหรับงานกลางแจ้งช่วยลดอันตรายจากการถูกไฟฟ้าดูด
- ▶ **หากไม่สามารถหลีกเลี่ยงการใช้เครื่องมือไฟฟ้าทำงานในสถานที่เปียกชื้นได้ ให้ใช้สวิทช์ตัดวงจรเมื่อเกิดการรั่วไหลของไฟฟ้าจากสายดิน** การใช้สวิทช์ตัดวงจรเมื่อเกิดการรั่วไหลของไฟฟ้าจากสายดินช่วยลดความเสี่ยงต่อการถูกไฟฟ้าดูด

ความปลอดภัยของบุคคล

- ▶ **ท่านต้องอยู่ในสภาพเตรียมพร้อม ระวังในสิ่งที่กำลังทำอยู่ และมีสติขณะใช้เครื่องมือไฟฟ้าทำงาน** อย่าใช้เครื่องมือไฟฟ้าขณะที่ท่านกำลังเหนื่อย หรืออยู่ภายใต้การครอบงำของฤทธิ์ของยาเสพติด แอลกอฮอล์ และยา เมื่อใช้เครื่องมือไฟฟ้าทำงาน ในชั่วนาทีที่ท่านขาดความเอาใจใส่อาจทำให้บุคคลบาดเจ็บอย่างรุนแรงได้

- ▶ **ใช้อุปกรณ์ปกป้องร่างกาย สวมแว่นตาป้องกันแสงมอ** อุปกรณ์ปกป้อง เช่น หน้กากากันฝุ่น รองเท้ากันลื่น หมวกแข็ง หรือประคบหูกันเสียงดัง ที่เลือกใช้ตามความเหมาะสมกับสภาพการทำงาน สามารถลดอันตรายต่อบุคคลได้
- ▶ **ป้องกันการติดเครื่องโดยไม่ตั้งใจ** ต้องดูให้แน่ใจว่าสวิทช์อยู่ในตำแหน่งปิดก่อนเสียบปลั๊กไฟเข้าในเต้าเสียบ และ/หรือใส่แท่งแบตเตอรี่ ยกขึ้นหรือถือเครื่องมือ การถือเครื่องโดยใช้นิ้วหัวที่สวิทช์ หรือเสียบปลั๊กไฟในขณะที่สวิทช์เปิดอยู่ อาจนำไปสู่อุบัติเหตุที่ร้ายแรงได้
- ▶ **เอาเครื่องมือปรับแต่งหรือประแจปากคายนอกจากเครื่องมือไฟฟ้าก่อนเปิดสวิทช์** เครื่องมือหรือประแจปากคายนี้อาจอยู่กับส่วนของเครื่องที่กำลังหมุนจะทำให้บุคคลบาดเจ็บได้
- ▶ **หลีกเลี่ยงการตั้งท่าที่ผิดปกติ** ตั้งท่ายืนที่มั่นคงและวางน้ำหนักให้สมดุลตลอดเวลา ในลักษณะนี้ท่านสามารถควบคุมเครื่องมือไฟฟ้าในสถานการณ์ที่ไม่คาดคิดได้ดีกว่า
- ▶ **ใส่เสื้อผ้าที่เหมาะสม** อย่าใส่เสื้อผ้าหลวมหรือสวมเครื่องประดับ เข็ม เสื้อผ้า และถุงมือออกห่างส่วนของเครื่องที่กำลังหมุน เสื้อผ้าหลวม เครื่องประดับ และผมยาวอาจเข้าไปติดในส่วนของเครื่องที่กำลังหมุนได้
- ▶ **หากต้องต่อเครื่องมือไฟฟ้าเข้ากับเครื่องดูดฝุ่นหรือเครื่องเก็บผง** ดูให้แน่ใจว่าการเชื่อมต่อและการใช้งานเป็นไปอย่างถูกต้อง การใช้อุปกรณ์ดูดฝุ่นช่วยลดอันตรายที่เกิดจากฝุ่นได้

การใช้และการดูแลรักษาเครื่องมือไฟฟ้า

- ▶ **อย่าใช้เครื่องมือไฟฟ้าอย่างหักโหม** ใช้เครื่องมือไฟฟ้าที่ถูกต้องตรงตามลักษณะงาน เครื่องมือไฟฟ้าที่ถูกต้องจะทำงานได้ดีกว่าและปลอดภัยกว่าในระดับสมรรถภาพที่ออกแบบไว้
- ▶ **อย่าใช้เครื่องมือไฟฟ้าที่สวิทช์เปิดปิดเสีย** เครื่องมือไฟฟ้าที่ไม่สามารถควบคุมการเปิดปิดด้วยสวิทช์ได้ เป็นเครื่องมือไฟฟ้าที่ไม่ปลอดภัยและต้องส่งซ่อมแซม
- ▶ **ก่อนปรับแต่งเครื่อง เปลี่ยนอุปกรณ์ประกอบ หรือเก็บเครื่องเข้าที่** ต้องถอดปลั๊กไฟออกจากเต้าเสียบ และ/หรือถอดแท่งแบตเตอรี่ออกจากเครื่องมือไฟฟ้ามาตรฐานป้องกันเพื่อความปลอดภัยซึ่งช่วยลดความเสี่ยงจากการติดเครื่องโดยไม่ตั้งใจ
- ▶ **เมื่อเลิกใช้งานเครื่องมือไฟฟ้า ให้เก็บเครื่องไว้ในที่ที่เด็กหยิบไม่ถึง และไม่อนุญาตให้บุคคลที่ไม่คุ้นเคยกับเครื่องหรือบุคคลที่ไม่ได้อ่านคำแนะนำนี้ใช้เครื่องมือไฟฟ้าเป็นของอันตรายหากตกอยู่ในมือของผู้ใช้ที่ไม่ได้รับการฝึกฝน**

20 | ภาษาไทย

- ▶ เอาใจใส่ดูแลรักษาเครื่อง ตรวจสอบหาส่วนที่เคลื่อนไหวได้ของเครื่องว่าวางอยู่ตรงแนวหรือติดขัดหรือไม่ ตรวจสอบการแตกหักของชิ้นส่วนและสภาพอื่นใดที่อาจมีผลต่อการทำงานของเครื่องมือไฟฟ้า หากชำรุดต้องส่งเครื่องมือไฟฟ้าซ่อมแซมก่อนใช้งาน อุบัติเหตุหลายอย่างเกิดขึ้นเนื่องจากดูแลรักษาเครื่องไม่ดีพอ
- ▶ รักษาเครื่องมือตัดให้คมและสะอาด หากบำรุงรักษาเครื่องมือที่มีขอบตัดแหลมคมอย่างถูกต้อง จะสามารถตัดได้ลื่นไม่ติดขัดและควบคุมได้ง่ายกว่า
- ▶ ใช้เครื่องมือไฟฟ้า อุปกรณ์ประกอบ เครื่องมือ และอุปกรณ์อื่นๆ ให้ตรงตามคำแนะนำ และในลักษณะตามที่เครื่องมือไฟฟ้าประเภทนั้นๆ กำหนดไว้ โดยต้องคำนึงถึงเงื่อนไขการทำงานและงานที่จะทำด้วย การใช้เครื่องมือไฟฟ้าทำงานที่ต่างไปจากวัตถุประสงค์การใช้งานของเครื่อง อาจนำไปสู่สถานการณ์ที่เป็นอันตรายได้

การใช้และการดูแลรักษาเครื่องที่ใช้แบตเตอรี่

- ▶ ชาร์จแบตเตอรี่ด้วยเครื่องชาร์จที่บริษัทผู้ผลิตระบุไว้เท่านั้น เครื่องชาร์จที่เหมาะสมสำหรับแบตเตอรี่ประเภทหนึ่ง หากนำไปชาร์จแบตเตอรี่ประเภทอื่น อาจเกิดไฟไหม้ได้
- ▶ ใช้แบตเตอรี่เฉพาะประเภทที่เครื่องมือไฟฟ้ากำหนดให้ใช้ได้ การใช้แบตเตอรี่ประเภทอื่นเสี่ยงต่อการเกิดไฟไหม้หรือบาดเจ็บ
- ▶ เมื่อไม่ใช้แบตเตอรี่ ให้เก็บแบตเตอรี่ไว้ห่างไกลวัตถุอื่นๆ เช่น คลิปหนีบกระดาษ เหรียญ กุญแจ ตะปู สกรู หรือโลหะวัตถุขนาดเล็กอื่นๆ ที่สามารถต่อขั้วหนึ่งไปยังอีกขั้วหนึ่งได้ การลัดวงจรของขั้วแบตเตอรี่อาจทำให้เกิดการไหม้หรือไฟลุกได้
- ▶ เมื่อใช้แบตเตอรี่ผิดวิธี อาจมีของเหลวไหลออกมาจากแบตเตอรี่ได้ ให้หลีกเลี่ยงการสัมผัสของเหลว หากสัมผัสโดยบังเอิญ ให้ใช้น้ำล้าง หากของเหลวเข้าตาให้ขอความช่วยเหลือจากแพทย์ด้วย ของเหลวที่ไหลออกมาจากแบตเตอรี่อาจทำให้เกิดอาการคันหรือแสบผิวหนังได้

การบริการ

- ▶ ส่งเครื่องมือไฟฟ้าให้ช่างผู้เชี่ยวชาญตรวจสอบและใช้อะไหล่เปลี่ยนของแท้เท่านั้น ในลักษณะนี้ท่านจะแน่ใจได้ว่าเครื่องมือไฟฟ้าอยู่ในสภาพที่ปลอดภัย

คำแนะนำเพื่อความปลอดภัยสำหรับ
ส่วนและไขควง

GSB 14,4 V-LI/GSB 18 V-LI

- ▶ สวมอุปกรณ์ป้องกันหูเมื่อเจาะกระแทก การได้รับเสียงดังอาจทำให้สูญเสียการได้ยิน

GSR 14,4 V-LI/GSR 18 V-LI/
GSB 14,4 V-LI/GSB 18 V-LI

- ▶ เมื่อทำงานในบริเวณที่เครื่องมือตัดหรือสกรูอาจสัมผัสกับสายไฟฟ้าที่ซ่อนอยู่ ต้องจับเครื่องมือไฟฟ้าตรงตามจับที่หุ้มฉนวน เครื่องมือตัดและสกรูที่สัมผัสกับสายที่มีกระแสไฟฟ้าไหลอยู่อาจทำให้ส่วนที่เป็นโลหะของเครื่องมือไฟฟ้าเกิด "มีกระแสไฟฟ้า" ด้วย และสามารถส่งผลให้ผู้ใช้เครื่องถูกไฟฟ้าดูดได้
- ▶ หากด้ามจับเพิ่มจัดส่งมาพร้อมกับเครื่อง ให้ใช้ด้ามจับเพิ่มร่วมด้วย การสูญเสียการควบคุมอาจทำให้บุคคลบาดเจ็บได้
- ▶ ใช้เครื่องตรวจที่เหมาะสมตรวจหาท่อและสายไฟฟ้าที่อาจซ่อนอยู่ในบริเวณที่จะทำงาน หรือขอความช่วยเหลือจากบริษัททางท่อและสายไฟฟ้าในห้องปฏิบัติการสัมผัสกับสาย ไฟฟ้าอาจทำให้เกิดไฟไหม้หรือถูกไฟฟ้าช็อกหรือดูดได้ การทำให้ท่อแก๊สเสียหายอาจเกิดระเบิดได้ การเจาะเข้าในท่อน้ำ ทำให้ทรัพย์สินเสียหาย
- ▶ ปิดเครื่องมือไฟฟ้าทันทีที่เครื่องมือที่ปล่อยเกิดติดขัดเตรียมตัวรับแรงบิดสะท้อนสูงที่ทำให้เกิดการตีกลับ เครื่องมือที่ปล่อยติดขัดเนื่องจาก:
 - เครื่องมือไฟฟ้าถูกใช้งานเกินกำลังปกติ หรือ
 - เครื่องมือที่มีม็อบอยู่ในชิ้นงาน
- ▶ จับเครื่องมือไฟฟ้าให้แน่น ขณะขันสกรูเข้าและคลายออก อาจเกิดแรงบิดสะท้อนช่วงสั้นๆ อย่างรุนแรงได้
- ▶ ยึดชิ้นงานให้แน่น การยึดชิ้นงานด้วยเครื่องมือหนีบหรือแท่นจับจะมั่นคงกว่าการยึดด้วยมือ
- ▶ รักษาสถานที่ทำงานให้สะอาด การผสมผสานของวัสดุก่อให้เกิดอันตรายอย่างยิ่ง ฝุ่นที่ได้จากโลหะนำหนักเบาอาจลุกไหม้หรือระเบิดได้
- ▶ อย่าเปิดแบตเตอรี่ด้วยตนเอง อันตรายจากการลัดวงจร



ปกป้องแบตเตอรี่จากความร้อน ต. ย. เช่น จากแสงแดดจ้าที่ส่องอย่างต่อเนื่อง ไฟ น้ำ และ



ความชื้น อันตรายจากการระเบิด

- ▶ ในกรณีที่แบตเตอรี่ชำรุดและใช้แบตเตอรี่อย่างไม่ถูกต้อง อาจมีไอระเหยออกมา ให้สูดอากาศบริสุทธิ์และหาแพทย์ในกรณีเจ็บปวด ไอระเหยอาจทำให้ระบบหายใจระคายเคือง
- ▶ ใช้แบตเตอรี่เฉพาะกับเครื่องมือไฟฟ้า ม็อบ ของท่านเท่านั้น การกระทำเช่นนี้เท่านั้นที่จะช่วยปกป้องแบตเตอรี่จากการถูกใช้งานเกินพิกัดซึ่งเป็นอันตราย
- ▶ ใช้เฉพาะแบตเตอรี่ของแท้ของ ม็อบ ที่มีแรงดันไฟฟ้าที่ระบุไว้บนแผ่นป้ายรุ่นของเครื่องมือไฟฟ้าของท่านเท่านั้น หากใช้แบตเตอรี่ประเภทอื่น ต. ย. เช่น แบตเตอรี่

ที่ลอกเลียนแบบ ซ่อมปรับปรุง หรือแบตเตอรี่ยี่ห้ออื่น จะเกิดอันตรายทำให้ร่างกายบาดเจ็บและทรัพย์สินเสียหายจากการระเบิดของแบตเตอรี่ได้

วิธีปฏิบัติงานและคำแนะนำ เพื่อความปลอดภัยเพิ่มเติม

- ▶ **ผู้ที่ได้จากวัสดุ เช่น เคลือบผิวที่มีตะกั่ว ไม้บางประเภท แร่ธาตุ และโลหะ อาจเป็นอันตรายต่อสุขภาพและทำให้เกิดอาการแพ้ นำไปสู่โรคติดเชื้อในระบบหายใจ และ/หรือโรคมะเร็ง** ผู้ทำงานกับวัสดุผสมแอสเบสทอสได้ต้องเป็นช่างผู้เชี่ยวชาญเท่านั้น
 - จัดสถานที่ทำงานให้มีการระบายอากาศที่ดี
 - ขอแนะนำให้สวมหน้ากากป้องกันการติดเชื้อที่มีระดับ-ไส้กรอง P2

ปฏิบัติตามกฎข้อบังคับสำคัญอื่นๆ ที่เกี่ยวกับวัสดุชิ้นงานที่บังคับใช้ในประเทศของท่าน







- ▶ **ป้องกันการสะสมของฝุ่นในสถานที่ทำงาน** ฝุ่นสามารถถูกใหม่อย่างง่ายดาย
- ▶ **ก่อนปรับแต่งเครื่อง (ต. ย. เช่น การบำรุงรักษา การเปลี่ยนเครื่องมือ ฯลฯ) รวมทั้งเมื่อเคลื่อนย้ายและเก็บเข้าที่ ให้ตั้งสวิทช์ปรับทิศทางหมุนไว้ที่ตำแหน่งกลางเสมอ** หากสวิทช์เปิด-ปิดถูกกดโดยไม่เจตนา อาจทำให้บุคคลบาดเจ็บได้
- ▶ **แบตเตอรี่ที่จัดส่งได้ถูกชาร์จมาบ้างแล้ว เพื่อให้แน่ใจว่าแบตเตอรี่จะทำงานได้เต็มที่ ให้ชาร์จแบตเตอรี่อย่างสมบูรณ์แบบในเครื่องชาร์จก่อนนำมาใช้งานครั้งแรก**
- ▶ **แบตเตอรี่ที่มีตัวควบคุมอุณหภูมิ NTC** ซึ่งจะอนุญาตให้ทำการชาร์จได้เฉพาะเมื่ออยู่ในพิสัยอุณหภูมิระหว่าง 0 °C และ 45 °C เท่านั้น ในลักษณะนี้แบตเตอรี่จะมีอายุการใช้งานยืนยาว
- ▶ **อ่านคู่มือการใช้งานเครื่องชาร์จแบตเตอรี่**
- ▶ **จับเครื่องมือไฟฟ้าวางบนสกรูเมื่อเครื่องปิดอยู่เท่านั้น** เครื่องมือที่กำลังหมุนอยู่สามารถทำให้สิ้นไถลได้
- ▶ **ปรับสวิทช์เกียร์เมื่อเครื่องหยุดนิ่งอยู่กับที่แล้วเท่านั้น**
- ▶ **ดันสวิทช์เกียร์และหมุนสวิทช์เลือกวิธีการปฏิบัติงานไปจนสุดเสมอ** มิฉะนั้นเครื่องอาจชำรุดได้
- ▶ **ในกรณีที่ใช้งานเกินปกติ ต. ย. เช่น เครื่องมือถูกกีดขวางเป็นเวลานาน ระบบอิเล็กทรอนิกส์จะปิดสวิทช์เครื่องมือไฟฟ้า หลังเปิดสวิทช์อีกครั้ง จะสามารถใช้เครื่องมือไฟฟ้าตามวัตถุประสงค์ได้อีกครั้งหนึ่ง ในกรณีที่ใช้งานเกินปกติต่อไป เครื่องมือไฟฟ้าจะปิดสวิทช์อีกครั้งนี้เพื่อป้องกันไม่ให้อุปกรณ์เสียหาย**

สัญลักษณ์

สัญลักษณ์ต่อไปนี้มีความสำคัญต่อการอ่านและการทำความเข้าใจคู่มือการใช้งานเครื่อง กรุณาจดจำสัญลักษณ์และความหมายของสัญลักษณ์ การแปลความสัญลักษณ์ได้ถูกต้องจะช่วยให้ท่านใช้เครื่องได้ดีและปลอดภัยกว่า

สัญลักษณ์	ความหมาย
	GSR 14,4 V-Li/GSR 18 V-Li/ GSB 14,4 V-Li/GSB 18 V-Li: ไขควงไร้สาย/สว่านไร้สาย บริเวณสีเทา: ต้มจับ (พื้นผิวจับหุ้มด้วยฉนวน)
	หมายเลขสินค้า X xxx xxx xxx
	ต้องอ่านคำเตือนเพื่อความปลอดภัยและคำสั่งทั้งหมด
	ถอดแบตเตอรี่ออก ก่อนทำการปรับแต่งเครื่อง
	ต้องสวมอุปกรณ์ป้องกันหู
	ทิศทางการเคลื่อนที่
	ทิศทางการตอบสนอง
	การเจาะและการขันสกรู
	การเจาะกระแทก
	ความเร็วต่ำ
	ความเร็วสูง
	เปิดเครื่องทำงาน
	ปิดเครื่อง
	การหมุนซ้าย/ขวา

22 | ภาษาไทย

สัญลักษณ์	ความหมาย
U	แรงดันไฟฟ้ากำหนด
n_s	อัตรากระแส
$n_0 1$	ความเร็วเดินตัวเปล่า (เกียร์ 1)
$n_0 2$	ความเร็วเดินตัวเปล่า (เกียร์ 2)
M	แรงบิดสูงสุด ตามมาตรฐาน ISO 5393
	งานก่อสร้าง
	โลหะ
	ไม้
\emptyset	เส้นผ่าศูนย์กลางรูเจาะ สูงสุด
\emptyset 	\emptyset -สกรู สูงสุด
	วงหนีบหัวจับดอก
	น้ำหนักตามระเบียบการ-EPTA- Procedure 01:2014
*	ขึ้นอยู่กับแบตเตอรี่แพ็คที่ใช้

รายการสิ่งของที่จัดส่ง

ไขควงไร้สาย/สว่านไร้สาย
แบตเตอรี่ เครื่องมือ อุปกรณ์ประกอบอื่นๆ ที่แสดงหรือระบุไม่
รวมอยู่ในการจัดส่งมาตรฐาน
กรุณาดูการอธิบายโดยสรุปทั้งหมดในโปรแกรมอุปกรณ์
ประกอบของเรา

ประโยชน์การใช้งานของเครื่อง

เครื่องนี้ใช้สำหรับขันสกรูเข้าและคลายออก และสำหรับเจาะ
ในไม้ โลหะ เซรามิกส์ และพลาสติก เครื่องรุ่น GSB ยังเหมาะ
ใช้สำหรับเจาะกระแทกในอิฐ งานก่อสร้าง และสิ่งก่อสร้างที่
ทำด้วยหินหรืออิฐ อีกด้วย

ข้อมูลทางเทคนิค

ข้อมูลทางเทคนิคของเครื่องได้ลงรายการไว้ในตารางหน้า 33
ของคู่มือการใช้งานเครื่องเล่มนี้
เครื่องแต่ละเครื่องอาจมีชื่อทางการค้าแตกต่างกัน ดังนั้น
กรุณาสังเกตหมายเลขสินค้าบนแผ่นป้ายรุ่นของเครื่องของ
ท่าน

การประกอบและการปฏิบัติงาน

ขั้นตอน	ภาพประกอบ	หน้า
การถอดแบตเตอรี่	1	34
การใส่แบตเตอรี่	2	34
การประกอบเครื่องมือ	3	34
การกลับทิศทางการหมุน	4	35
การตั้งแรงบิด	5	35
การเลือกตำแหน่งเจาะ	6	36
การตั้งวิธีการปฏิบัติงาน	7	36
การเลือกเกียร์ ระบบกลไก	8	36
การเปิดและปิดสวิตช์	9	37
การเลือกอุปกรณ์ประกอบ	-	38

การบำรุงรักษาและการทำความสะอาด

► เพื่อให้ทำงานได้อย่างถูกต้องและปลอดภัย ต้องรักษา
เครื่องและช่องระบายอากาศให้สะอาดอยู่เสมอ
ทำความสะอาดเครื่องมือ หัวจับดอก ช่องระบายอากาศของ
เครื่องมือไฟฟ้า และช่องระบายอากาศของแบตเตอรี่ ทุกครั้ง
หลังเลิกใช้งาน

การบริการหลังการขายและคำแนะนำการใช้งาน

ศูนย์บริการหลังการขายของเรายินดีตอบคำถามเกี่ยวกับ
การบำรุงรักษาและการซ่อมแซมผลิตภัณฑ์ของท่าน รวมทั้ง
ชิ้นส่วนอะไหล่ ภาพแยกชิ้นประกอบและข้อมูลเกี่ยวกับ
ชิ้นส่วนอะไหล่ยังสามารถดูได้ที่:
www.bosch-pt.com
ทีมงานให้คำแนะนำการใช้งานของ มีอช ยินดีตอบคำถาม
เกี่ยวกับผลิตภัณฑ์ของเราและอุปกรณ์ประกอบของผลิตภัณฑ์

เมื่อต้องการสอบถามและสั่งซื้ออะไหล่ กรุณาแจ้งหมายเลข
สินค้าลับหลักบนแผ่นป้ายรุ่นของเครื่องทุกครั้ง
ในกรณีประกัน ซ่อมแซม หรือซื้อชิ้นส่วนมาเปลี่ยน
กรุณาติดต่อ ผู้ขายที่ได้รับแต่งตั้งเท่านั้น

ประเทศไทย

สำนักงาน

บริษัท โรเบิร์ต บ็อส จำกัด
ชั้น 11 ดิกลีเบอร์ตี้ สแควร์
287 ถนนสีลม
กรุงเทพฯ 10500
โทรศัพท์ 02 / 6 31 18 79 – 18 88 (10 หมายเลข)
โทรสาร 02 / 2 38 47 83
www.bosch.co.th

ศูนย์บริการ

บริษัท โรเบิร์ต บ็อส จำกัด
แผนกเครื่องมือไฟฟ้า
ตู้ ปณ. 20 54
กรุงเทพฯ 10501
ประเทศไทย

ศูนย์บริการซ่อมและฝึกอบรม

ศูนย์บริการซ่อมและฝึกอบรมบ็อส
2869 – 2869/1 ซอยบ้านเกล้า
ถนนพระรามที่ 4 (ใกล้ทางรถไฟสายปากน้ำเก่า)
พระโขนง
กรุงเทพฯ 10110
ประเทศไทย
โทรศัพท์ 02 / 6 71 78 00 – 4
โทรสาร 02 / 2 49 42 96
โทรสาร 02 / 2 49 52 99

การขนส่ง

แบตเตอรี่ลิเธียม ไอออน ที่บรรจุอยู่ภายใต้ข้อกำหนดแห่ง
กฎหมายสินค้าอันตราย ผู้ใช้สามารถขนส่งแบตเตอรี่โดยทาง
ถนนโดยไม่มีข้อบังคับอื่น

หากขนส่งโดยบุคคลที่สาม (เช่น: การขนส่งทางอากาศ หรือ
ตัวแทนขนส่งสินค้า) ต้องปฏิบัติตามข้อกำหนดพิเศษเกี่ยวกับการ
การบรรจุภัณฑ์และการติดฉลาก ในการจัดเตรียมสิ่งของที่จะ
จัดส่ง ต้องปรึกษาผู้เชี่ยวชาญสำหรับวัตถุดิบอันตราย

ส่งแบตเตอรี่เมื่อตัวหุ้มไม่ชำรุดเสียหายเท่านั้น ใช้แถบกาวพัน
ปิดหน้าสัมผัสที่เปิดอยู่ และนำแบตเตอรี่ใส่กล่องบรรจุโดยไม่
ให้เคลื่อนไปมาในกล่องได้

นอกจากนี้ กรุณาปฏิบัติตามกฎระเบียบของประเทศซึ่งอาจมี
รายละเอียดเพิ่มเติม

การกำจัดขยะ



เครื่อง แบตเตอรี่ที่นำกลับมาชาร์จใหม่ได้ อุปกรณ์
ประกอบ และหีบห่อ ต้องนำไปแยกประเภทวัสดุ
เพื่อนำกลับมาใช้ใหม่โดยไม่ทำลายสภาพแวดล้อม

อย่าทิ้งเครื่องมือไฟฟ้าและแบตเตอรี่/แบตเตอรี่ที่นำกลับมา
ชาร์จใหม่ได้ ลงในขยะบ้าน!

แบตเตอรี่แพ็ค/แบตเตอรี่:

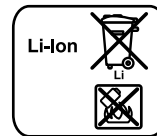

Li-ion:

กรุณาปฏิบัติตามคำสั่งในบท
"การขนส่ง" หน้า 23

ขอสงวนสิทธิ์ในการเปลี่ยนแปลงโดยไม่ต้องแจ้งล่วงหน้า

Bahasa Indonesia

Petunjuk-Petunjuk Umum untuk Perkakas Listrik

⚠ PERHATIKANLAH

Bacalah semua petunjuk-
petunjuk untuk keselamatan
kerja dan petunjuk-petunjuk untuk penggunaan.

Kesalahan dalam menjalankan petunjuk-petunjuk untuk
keselamatan kerja dan petunjuk-petunjuk untuk penggunaan
dapat mengakibatkan kontak listrik, kebakaran dan/atau luka-
luka yang berat.

Simpanlah semua petunjuk-petunjuk untuk keselamatan
kerja dan petunjuk-petunjuk lainnya untuk penggunaan di
masa depan.

Kata „perkakas listrik“ yang disebutkan di dalam petunjuk-
petunjuk untuk keselamatan kerja adalah sebutan untuk
perkakas listrik pakai listrik jaringan (dengan kabel) dan
untuk perkakas listrik tenaga baterai (tanpa kabel listrik).

Keselamatan kerja di tempat kerja

- ▶ **Jagalah supaya tempat kerja selalu bersih dan terang.**
Tempat kerja yang tidak rapi atau tidak terang dapat
mengakibatkan terjadinya kecelakaan.
- ▶ **Janganlah menggunakan perkakas listrik di tempat di
mana dapat terjadi ledakan, di mana ada cairan, gas
atau debu yang mudah terbakar.** Perkakas listrik dapat
memancarkan bunga api yang lalu mengakibatkan debu
atau uap terbakar.
- ▶ **Selama menggunakan perkakas listrik, jauhkan anak-
anak dan orang-orang lain dari tempat kerja.** Jika
konsentrasi terganggu, bisa jadi Anda tidak bisa mengendalikannya
perkakas listrik tersebut.

Keamanan listrik

- ▶ **Steker dari perkakas listrik harus cocok pada stopkontak. Janganlah sekali-kali merubah steker. Janganlah menggunakan steker perantara bersama dengan perkakas listrik yang mempunyai hubungan arde.** Steker yang tidak dirubah dan stopkontak yang cocok mengurangi bahaya terjadinya kontak listrik.
- ▶ **Jagalah supaya badan Anda tidak bersentuhan dengan permukaan yang mempunyai hubungan arde, misalnya pipa-pipa, radiator pemanas ruangan, kompor listrik dan lemari es.** Ada risiko besar terjadi kontak listrik, jika badan Anda mempunyai hubungan arde.
- ▶ **Jagalah supaya perkakas listrik tidak kena hujan atau menjadi basah.** Air yang masuk ke dalam perkakas listrik menambah risiko terjadinya kontak listrik.
- ▶ **Janganlah menyalah gunakan kabel listrik untuk mengangkat dan menggantungkan perkakas listrik atau untuk menarik steker dari stopkontak. Jagalah supaya kabel listrik tidak kena panas, minyak, pinggiran yang tajam atau bagian-bagian perkakas yang bergerak.** Kabel listrik yang rusak atau tersangkut menambah risiko terjadinya kontak listrik.
- ▶ **Jika Anda menggunakan perkakas listrik di luar gedung, gunakanlah hanya kabel sambungan yang juga cocok untuk pemakaian di luar gedung.** Penggunaan kabel sambungan yang cocok untuk pemakaian di luar gedung mengurangi risiko terjadinya kontak listrik.
- ▶ **Jika penggunaan perkakas listrik di tempat yang basah tidak bisa dihindarkan, gunakanlah sakelar pengaman terhadap arus penyimpangan.** Penggunaan sakelar pengaman terhadap arus penyimpangan mengurangi risiko terjadinya kontak listrik.

Keselamatan kerja

- ▶ **Berhati-hatilah selalu, perhatikanlah apa yang Anda kerjakan dan bekerjalah dengan seksama jika menggunakan perkakas listrik. Janganlah menggunakan perkakas listrik, jika Anda capai atau berada di bawah pengaruh narkoba, minuman keras atau obat.** Jika Anda sekejap mata saja tidak berhati-hati sewaktu menggunakan perkakas listrik, dapat terjadi luka-luka berat.
- ▶ **Pakailah pakaian dan sarana pelindung dan pakailah selalu kaca mata pelindung.** Dengan memakai pakaian dan sarana pelindung, misalnya kedok anti debu (masker), sepatu tertutup yang tidak licin, helm pelindung atau pemalut telinga sesuai dengan pekerjaan yang dilakukan dengan perkakas listrik, bahaya terjadinya luka-luka dapat dikurangi.
- ▶ **Jagalah supaya perkakas listrik tidak dihidupkan secara tidak disengaja. Perhatikan bahwa perkakas listrik dalam penyetelan mati, jika steker disambungkan pada pengadaan listrik dan/atau baterai, jika perkakas listrik diangkat atau dibawa.** Jika selama mengangkat perkakas listrik jari Anda berada pada tombol untuk menghidupkan dan mematikan atau perkakas listrik yang dalam penyetelan hidup disambungkan pada listrik, dapat terjadi kecelakaan.

- ▶ **Lepaskan semua perkakas-perkakas penyetelan atau kunci-kunci pas sebelum perkakas listrik dihidupkan.** Perkakas atau kunci yang berada di dalam bagian yang berputar dapat mengakibatkan terjadinya luka-luka.
- ▶ **Aturkan badan sedemikian sehingga Anda bisa bekerja dengan aman. Berdirilah secara mantap dan jagalah selalu keseimbangan.** Dengan demikian Anda bisa mengendalikan perkakas listrik dengan lebih baik, jika terjadi sesuatu dengan tiba-tiba.
- ▶ **Pakailah pakaian yang cocok. Janganlah memakai pakaian yang longgar atau perhiasan. Jagalah supaya rambut, pakaian dan sarung tangan tidak masuk dalam bagian-bagian perkakas yang bergerak.** Pakaian yang longgar, rambut panjang atau perhiasan dapat tersangkut dalam bagian perkakas yang bergerak.
- ▶ **Jika ada kemungkinan untuk memasangkan sarana penghisapan dan penampungan debu, perhatikan bahwa sarana-sarana ini telah dipasang dan digunakan dengan betul.** Penggunaan sarana penghisapan bisa mengurangi bahaya yang disebabkan debu.

Penggunaan dan penanganan perkakas listrik dengan seksama

- ▶ **Janganlah membebankan perkakas listrik terlalu berat. Gunakan selalu perkakas listrik yang cocok untuk pekerjaan yang dilakukan.** Dengan perkakas listrik yang cocok Anda bekerja lebih baik dan lebih aman dalam batas-batas kemampuan yang ditentukan.
- ▶ **Janganlah menggunakan perkakas listrik yang tombolnya rusak.** Perkakas listrik yang tidak bisa dihidupkan atau dimatikan, berbahaya dan harus direparasikan.
- ▶ **Tariklah steker dari stopkontak dan/atau keluarkan baterai, sebelum Anda melakukan penyetelan pada perkakas listrik, mengganti alat-alat kerja atau sebelum menyimpan perkakas listrik.** Tindakan keselamatan kerja ini mengurangi bahaya perkakas listrik hidup secara tidak disengaja.
- ▶ **Simpanlah perkakas listrik yang tidak digunakan di luar jangkauan anak-anak. Janganlah mengizinkan orang-orang yang tidak mengenal perkakas listrik ini atau yang belum membaca petunjuk-petunjuk ini, menggunakan perkakas listrik ini.** Perkakas listrik bisa menjadi berbahaya, jika digunakan oleh orang-orang yang tidak mengenalnya.
- ▶ **Rawatlah perkakas listrik dengan seksama. Periksalah, apakah bagian-bagian perkakas listrik yang bergerak berfungsi dengan baik dan tidak tersangkut, apakah ada bagian-bagian yang patah atau rusak sedemikian, sehingga dapat mempengaruhi jalannya perkakas listrik. Biarkan bagian-bagian perkakas yang rusak direparasikan, sebelum Anda mulai menggunakan perkakas listrik.** Banyak kecelakaan terjadi karena perkakas listrik tidak dirawat dengan seksama.

- ▶ **Perhatikan supaya alat-alat pemotong selalu tajam dan bersih.** Alat-alat pemotong dengan mata-mata pemotong yang tajam dan dirawat dengan seksama tidak mudah tersangkut dan lebih mudah dikendalikan.
- ▶ **Gunakanlah semua perkakas listrik, aksesoris, alat-alat kerja dsb. sesuai dengan petunjuk-petunjuk. Perhatikan syarat-syarat kerja dan macam pekerjaan yang dilakukan.** Penggunaan perkakas listrik untuk macam pekerjaan yang tidak cocok dengan kegunaannya bisa mengakibatkan keadaan yang berbahaya.

Penanganan dan penggunaan perkakas-perkakas pakai baterai dengan seksama

- ▶ **Isikan baterai hanya dalam alat-alat pencas baterai yang dianjurkan oleh pabrik.** Jika suatu alat pencas baterai yang cocok untuk mengisi satu macam baterai tertentu, digunakan untuk mengisi baterai-baterai lainnya, ada bahaya terjadinya kebakaran.
- ▶ **Gunakanlah hanya baterai-baterai yang cocok dan khusus untuk masing-masing perkakas listrik.** Penggunaan baterai-baterai lain dapat mengakibatkan terjadinya luka-luka dan kebakaran.
- ▶ **Jika baterai tidak digunakan, jauhkan baterai dari klip untuk kertas, uang logam, kunci, paku, sekrup atau benda-benda kecil dari logam lainnya, yang dapat menjembatani kontak-kontak.** Korsleting antara kontak-kontak baterai dapat mengakibatkan kebakaran atau api.
- ▶ **Jika baterai tidak digunakan dengan betul, dapat keluar cairan dari baterai. Jagalah supaya Anda tidak terkena pada cairan ini. Jika secara tidak disengaja Anda terkena pada cairan ini, cucikan dengan air. Jika cairan tersebut terkena pada mata, selain tindakan di atas, segera hubungi seorang dokter.** Cairan yang keluar dari baterai dapat mengakibatkan gangguan pada kulit atau kebakaran.

Servis

- ▶ **Biarkan perkakas listrik Anda direparasikan hanya oleh orang-orang ahli yang berpengalaman dan hanya dengan menggunakan suku cadang yang asli.** Dengan demikian terjamin keselamatan kerja dengan perkakas listrik ini secara berkesinambungan.

Petunjuk-Petunjuk untuk Keselamatan Kerja untuk Mesin Bor dan Obeng Elektro

GSB 14,4 V-LI/GSB 18 V-LI

- ▶ **Pakailah pemalut telinga selama membor dengan getaran.** Jika Anda mendengar suara bising, daya pendengaran bisa berkurang.

GSR 14,4 V-LI/GSR 18 V-LI/ GSB 14,4 V-LI/ GSB 18 V-LI

- ▶ **Peganglah perkakas listrik hanya pada pegangan yang terisolir, jika Anda melakukan pekerjaan di mana alat kerjanya atau sekrup bisa terkena pada saluran listrik yang tidak terlihat.** Sentuhan pada kabel yang bertegangan dapat mengakibatkan bagian-bagian logam dari perkakas listrik juga bertegangan dan lalu mengakibatkan kontak listrik.
- ▶ **Gunakanlah gagang tambahan-gagang tambahan, jika ini dipasok bersama dengan perkakas listrik.** Perkakas listrik yang tidak bisa dikendalikan bisa mengakibatkan terjadinya luka-luka.
- ▶ **Gunakanlah alat detektor logam yang cocok untuk mencari kabel dan pipa pengalasan yang tidak terlihat, atau hubungi perusahaan pengalasan setempat.** Sentuhan dengan kabel-listrik bisa mengakibatkan api dan kontak listrik. Pipa gas yang dirusak bisa mengakibatkan ledakan. Pipa air yang dirusak mengakibatkan barang-barang menjadi rusak.
- ▶ **Matikanlah segera perkakas listrik, jika alat kerjanya memblok. Berwaspadalah akan terjadinya momen reaksi yang besar yang mengakibatkan bantingan.** Alat kerja memblok jika:
 - perkakas listrik dibebankan terlalu berat atau
 - alat kerja tersangkut dalam benda yang dikerjakan.
- ▶ **Peganglah perkakas listrik secara kencang.** Pada waktu memutar masuk dan memutar ke luar sekrup bisa terjadi momen yang besar untuk waktu yang singkat.
- ▶ **Usahakan supaya benda yang dikerjakan tidak goyang.** Benda yang ditahan dalam alat pemegang atau bais lebih mantap daripada benda yang dipegang dengan tangan.
- ▶ **Jagalah supaya tempat di mana Anda bekerja selalu bersih.** Campuran bahan-bahan sangat membahayakan. Debu logam ringan bisa terbakar atau meledak.
- ▶ **Janganlah membuka baterai.** Ada bahaya terjadinya korsleting.



Lindungilah baterai terhadap panas, misalnya juga terhadap penyinaran matahari yang lama, api, air dan kelembaban. Ada bahaya terjadinya ledakan.



- ▶ **Jika baterai rusak dan jika baterai digunakan salah, baterai bisa mengeluarkan uap. Biarkan udara segar mengalir masuk dan jika Anda merasa tidak enak badan, pergilah ke dokter.** Uap tersebut bisa mengganggu saluran pernafasan.
- ▶ **Gunakanlah baterai hanya bersama dengan perkakas listrik merek Bosch.** Hanya dengan demikian baterai dilindungi terhadap pembebanan terlalu berat yang berbahaya.
- ▶ **Gunakanlah hanya baterai asli yang bermerek Bosch dengan tegangan yang tercantum pada label tipe perkakas listrik.** Jika digunakan baterai lainnya, misalnya baterai tiruan, baterai lama yang diperbarui atau baterai yang bermerek lain, bisa terjadi luka-luka serta kerusakan pada benda yang disebabkan oleh baterai yang meledak.







Petunjuk-petunjuk lainnya untuk keselamatan kerja dan untuk penggunaan

- ▶ **Debu dari berbagai bahan misalnya cat yang mengandung timbel, beberapa jenis kayu, bahan mineral dan logam bisa berbahaya bagi kesehatan dan mengakibatkan reaksi alergi, penyakit saluran pernafasan dan/atau kanker.** Bahan-bahan yang mengandung asbes hanya boleh dikerjakan oleh orang-orang ahli yang berpengalaman.
 - Perhatikanlah supaya ada pertukaran udara di tempat kerja.
 - Kami anjurkan supaya Anda memakai kedok anti debu dengan saringan (filter) kelas P2.
 Taatilah peraturan-peraturan untuk bahan-bahan yang dikerjakan yang berlaku di negara Anda.
- ▶ **Hindari debu yang banyak terkumpul di tempat kerja.** Debu dapat menyulut dengan mudahnya.
- ▶ **Sebelum melakukan semua pekerjaan pada perkakas listrik (misalnya merawat, mengganti alat kerja dsb.) serta selama mentranspor dan menyimpan perkakas listrik, putarkan pengubah arah putaran ke kedudukan tengah.** Jika tombol untuk menghidupkan dan mematikan mesin digerakkan tanpa sengaja, bisa terjadi luka-luka.
- ▶ **Baterai dipasang dalam keadaan diisi sebagian. Untuk menjamin daya penuh dari baterai, sebelum penggunaannya untuk pertama kalinya, isikanlah baterai sampai penuh sama sekali di dalam alat pencas baterai.**
- ▶ **Aki (baterai) dilengkapi dengan penjaga suhu NTC yang memungkinkan pengisian aki hanya pada tingkatan suhu antara 0 °C dan 45 °C. Dengan demikian aki (baterai) tahan lama.**
- ▶ **Bacalah petunjuk-petunjuk untuk penggunaan alat pencas baterai.**
- ▶ **Pasangkan perkakas listrik pada sekrup hanya jika perkakas listrik dalam keadaan mati.** Alat kerja-alat kerja yang berputar bisa meleset.
- ▶ **Sakelar untuk memilih tingkatan putaran hanya boleh digerakkan, jika perkakas listrik sedang berhenti.**
- ▶ **Geserkan sakelar untuk memilih tingkatan putaran atau putarkan omsakelar untuk memilih jenis pekerjaan selalu sampai batas.** Jika tidak, perkakas listrik bisa menjadi rusak.
- ▶ **Jika perkakas listrik dibebankan terlalu berat, misalnya jika alat kerja memblok untuk waktu yang lama, elektronika mematikan perkakas listrik. Jika perkakas listrik dihidupkan kembali, perkakas listrik dapat digunakan sesuai dengan kegunaannya. Jika perkakas listrik dibebankan lagi terlalu berat, perkakas listrik kembali padam, ini untuk menghindari motor menjadi rusak.**

Simbol-Symbol

Simbol-simbol berikut penting pada waktu membaca dan untuk mengerti petunjuk-petunjuk untuk penggunaan. Lihat dan ingati simbol-simbol dan artinya. Penafsiran yang betul dari simbol-simbol sangat membantu Anda untuk menggunakan perkakas listrik dengan jitu dan sesuai dengan petunjuk untuk keselamatan kerja.

Simbol	Arti
	GSR 14,4 V-LI/GSR 18 V-LI/ GSB 14,4 V-LI/GSB 18 V-LI: Obeng elektro pakai aki/ Mesin kunci/ bor getaran pakai aki Bidang berwarna abu-abu: gagang (permukaan yang dipegang dengan isolasi)
	Nomor model
	Bacalah semua petunjuk-petunjuk untuk keselamatan kerja dan petunjuk-petunjuk untuk penggunaan
	Sebelum memulai semua pekerjaan pada perkakas listrik, keluarkanlah dahulu baterai
	Pakailah pemalut telinga
	Arah gerakan
	Arah reaksi
	Membor dan menyekrup
	Membor dengan getaran
	Kecepatan putaran rendah
	Kecepatan putaran tinggi
	Menghidupkan perkakas listrik
	Mematikan perkakas listrik
	Putaran ke kanan/kiri

Simbol	Arti
U	Tegangan nominal
n_s	Banyaknya getaran
$n_0 1$	Kecepatan putaran tanpa beban (tingkatan putaran ke 1)
$n_0 2$	Kecepatan putaran tanpa beban (tingkatan putaran ke 2)
M	Momen putar maks. menurut ISO 5393
	Tembok
	Logam
	Kayu
\emptyset	Diameter maks. pemboran
	\emptyset -sekrup maks.
	Kepala cekam yang bisa memegang mata bor
	Berat sesuai dengan EPTA-Procedure 01:2014
*	tergantung dari baterai yang digunakan

Pasokan standar

Mesin bor/obeng pakai aki/mesin kunci/bor getaran pakai aki. Aki, alat kerja dan aksesoris lainnya yang ada dalam gambar atau yang dijelaskan, tidak termasuk mesin standar yang dipasok.

Semua aksesoris yang tersedia dapat Anda lihat di dalam program aksesoris.

Penggunaan alat

Perkakas listrik ini cocok untuk memutar masuk dan memutar ke luar sekrup dan baut serta untuk membor di kayu, logam, keramik dan bahan sintetik. Model GSB selain itu cocok untuk membor dengan getaran di batu bata, tembok dan batu-batuan.

Data teknis

Data-data teknis dari produk ini tertera di dalam tabel pada halaman 33 dari petunjuk-petunjuk untuk penggunaan ini.

Perhatikanlah nomor model perkakas listrik Anda yang tercantum pada label tipe mesin. Nama dagang dari beberapa perkakas listrik bisa berbeda.

Memasang dan menggunakan

Kegiatan	Gambar	Halaman
Cara mengeluarkan baterai	1	34
Memasang baterai	2	34
Memasang alat kerja	3	34
Menyetel arah putaran	4	35
Penyetelan pendahuluan momen putar	5	35
Memilih kedudukan bor	6	36
Menyetel macam pekerjaan	7	36
Memilih tingkatan putaran secara mekanis	8	36
Menghidupkan/mematikan	9	37
Memilih aksesoris	-	38

Rawatan dan kebersihan

- **Perkakas listrik dan lubang ventilasi harus selalu dibersihkan supaya perkakas bisa digunakan dengan baik dan aman.**

Setelah setiap penggunaan, bersihkanlah alat kerja, pemegang alat kerja dan lubang ventilasi perkakas listrik serta lubang ventilasi baterai (aki).

Layanan pasca beli dan konseling terkait pengoperasian

Layanan pasca beli Bosch menjawab semua pertanyaan Anda terkait reparasi dan maintenance serta suku cadang produk ini. Gambar tiga dimensi dan informasi terkait suku cadang dapat Anda lihat di:

www.bosch-pt.com

Tim konseling pengoperasian dari Bosch dengan senang hati membantu Anda, jika Anda hendak bertanya tentang produk-produk kami dan aksesorisnya.

Jika Anda hendak menanyakan sesuatu atau memesan suku cadang, sebutkan selalu nomor model yang terdiri dari 10 angka dan tercantum pada label tipe perkakas.

Indonesia

PT. Multi Mayaka
Kawasan Industri Pulogadung
Jalan Rawa Gelam III No. 2
Jakarta 13930
Indonesia
Tel.: (021) 46832522
Fax: (021) 46828645/6823
E-Mail: sales@multimayaka.co.id
www.bosch-pt.co.id

28 | Tiếng Việt

Transpor

Pada baterai-baterai ion-Li yang digunakan diterapkan persyaratan terkait peraturan-peraturan tentang bahan-bahan yang berbahaya. Baterai-baterai dapat diangkut oleh penggunanya di jalanan tanpa harus memenuhi syarat-syarat tertentu.

Pada pengiriman oleh pihak ketiga (misalnya transportasi dengan pesawat udara atau perusahaan ekspedisi) harus ditaati syarat-syarat terkait kemasan dan pemberian tanda. Dalam hal ini, untuk mempersiapkan transportasi harus diminta dukungan seorang ahli bahan-bahan berbahaya. Kirimkan baterai hanya jika rumahannya tidak rusak. Kontak kontak yang terbuka harus ditutupi dengan pita perekat dan kemaskan baterai sedemikian, sehingga baterai tidak bergerak-gerak di dalam kemasan. Taatilah peraturan-peraturan nasional lainnya yang mungkin lebih rinci yang berlaku di negara Anda.

Cara membuang

Semua perkakas listrik, baterai, aksesoris dan kemasan sebaiknya didaur ulang sesuai dengan upaya untuk melindungi lingkungan hidup.

Janganlah membuang perkakas listrik, aki/baterai ke dalam sampah rumah tangga!

Baterai isi ulang/Baterai:

Ion-Li:
Perhatikanlah petunjuk-petunjuk dalam bab „Transpor“, halaman 28.

Perubahan adalah hak Bosch.

Tiếng Việt**Cảnh báo tổng quát cách sử dụng an toàn dụng cụ điện cầm tay**

⚠ CẢNH BÁO Đọc kỹ mọi cảnh báo an toàn và hướng dẫn. Không tuân thủ mọi cảnh báo và hướng dẫn được liệt kê dưới đây có thể bị điện giật, gây cháy và/hay bị thương tật nghiêm trọng.

Hãy giữ tất cả tài liệu về cảnh báo và hướng dẫn để tham khảo về sau.

Thuật ngữ “dụng cụ điện cầm tay” trong phần cảnh báo là để cập đến sự sử dụng dụng cụ điện cầm tay của bạn, loại sử dụng điện nguồn (có dây cắm điện) hay vận hành bằng pin (không dây cắm điện).

Khu vực làm việc an toàn

- ▶ **Giữ nơi làm việc sạch và đủ ánh sáng.** Nơi làm việc bừa bộn và tối tăm dễ gây ra tai nạn.
- ▶ **Không vận hành dụng cụ điện cầm tay trong môi trường dễ gây nổ, chẳng hạn như nơi có chất lỏng dễ cháy, khí đốt hay rác.** Dụng cụ điện cầm tay tạo ra các tia lửa nên có thể làm rác bén cháy hay bốc khói.
- ▶ **Không để trẻ em hay người đến xem đứng gần khi vận hành dụng cụ điện cầm tay.** Sự phân tâm có thể gây ra sự mất điều khiển.

An toàn về điện

- ▶ **Phích cắm của dụng cụ điện cầm tay phải thích hợp với ổ cắm. Không bao giờ được cài biến lại phích cắm dưới mọi hình thức. Không được sử dụng phích tiếp hợp nối tiếp đất (dây mát).** Phích cắm nguyên bản và ổ cắm đúng loại sẽ làm giảm nguy cơ bị điện giật.
- ▶ **Tránh không để thân thể tiếp xúc với đất hay các vật có bề mặt tiếp đất như đường ống, lò sưởi, hàng rào và tủ lạnh.** Có nhiều nguy cơ bị điện giật hơn nếu cơ thể bạn bị tiếp hay nối đất.
- ▶ **Không được để dụng cụ điện cầm tay ngoài mưa hay ở tình trạng ẩm ướt.** Nước vào máy sẽ làm tăng nguy cơ bị điện giật.
- ▶ **Không được lạm dụng dây dẫn điện. Không bao giờ được nắm dây dẫn để xách, kéo hay rút phích cắm dụng cụ điện cầm tay. Không để dây gắn nơi có nhiệt độ cao, dầu nhớt, vật nhọn bén hay bộ phận chuyển động.** Làm hỏng hay cuộn rối dây dẫn làm tăng nguy cơ bị điện giật.
- ▶ **Khi sử dụng dụng cụ điện cầm tay ngoài trời, dùng dây nối thích hợp cho việc sử dụng ngoài trời.** Sử dụng dây nối thích hợp cho việc sử dụng ngoài trời làm giảm nguy cơ bị điện giật.
- ▶ **Nếu việc sử dụng dụng cụ điện cầm tay ở nơi ẩm ướt là không thể tránh được, dùng thiết bị ngắt mạch tự động (RCD) bảo vệ nguồn.** Sử dụng thiết bị ngắt mạch tự động RCD làm giảm nguy cơ bị điện giật.

An toàn cá nhân

- ▶ **Hãy tỉnh táo, biết rõ mình đang làm gì và hãy sử dụng ý thức khi vận hành dụng cụ điện cầm tay. Không sử dụng dụng cụ điện cầm tay khi đang mệt mỏi hay đang bị tác động do chất gây nghiện, rượu hay dược phẩm gây ra.** Một thoáng mất tập trung khi đang vận hành dụng cụ điện cầm tay có thể gây thương tích nghiêm trọng cho bản thân.

- ▶ **Sử dụng trang bị bảo hộ cá nhân. Luôn luôn đeo kính bảo vệ mắt.** Trang bị bảo hộ như khẩu trang, giày chống trượt, nón bảo hộ, hay dụng cụ bảo vệ tai khi được sử dụng đúng nơi đúng chỗ sẽ làm giảm nguy cơ thương tật cho bản thân.
- ▶ **Phòng tránh máy khởi động bất ngờ. Bảo đảm công tắc máy ở vị trí tắt trước khi cắm vào nguồn điện và/hay lắp pin vào, khi nhắc máy lên hay khi mang xách máy.** Ngáng ngón tay vào công tắc máy để xách hay kích hoạt dụng cụ điện cầm tay khi công tắc ở vị trí mở để dẫn đến tai nạn.
- ▶ **Lấy mọi chìa hay khóa điều chỉnh ra trước khi mở điện dụng cụ điện cầm tay.** Khóa hay chìa còn gắn dính vào bộ phận quay của dụng cụ điện cầm tay có thể gây thương tích cho bản thân.
- ▶ **Không rướn người. Luôn luôn giữ tư thế đứng thích hợp và thẳng bằng.** Điều này tạo cho việc điều khiển dụng cụ điện cầm tay tốt hơn trong mọi tình huống bất ngờ.
- ▶ **Trang phục thích hợp. Không mặc quần áo rộng lủng thụng hay mang trang sức. Giữ tóc, quần áo và găng tay xa khỏi các bộ phận chuyển động.** Quần áo rộng lủng thụng, đồ trang sức hay tóc dài có thể bị cuốn vào các bộ phận chuyển động.
- ▶ **Nếu có các thiết bị đi kèm để nối máy hút bụi và các phụ kiện khác, bảo đảm các thiết bị này được nối và sử dụng tốt.** Việc sử dụng các thiết bị gom hút bụi có thể làm giảm các độc hại liên quan đến bụi gây ra.

Sử dụng và bảo dưỡng dụng cụ điện cầm tay

- ▶ **Không được ép máy. Sử dụng dụng cụ điện cầm tay đúng loại theo đúng ứng dụng của bạn.** Dụng cụ điện cầm tay đúng chức năng sẽ làm việc tốt và an toàn hơn theo đúng tiến độ mà máy được thiết kế.
- ▶ **Không sử dụng dụng cụ điện cầm tay nếu như công tắc không tắt và mở được.** Bất kỳ dụng cụ điện cầm tay nào mà không thể điều khiển được bằng công tắc là nguy hiểm và phải được sửa chữa.
- ▶ **Rút phích cắm ra khỏi nguồn điện và/hay pin ra khỏi dụng cụ điện cầm tay trước khi tiến hành bất kỳ điều chỉnh nào, thay phụ kiện, hay cất dụng cụ điện cầm tay.** Các biện pháp ngăn ngừa như vậy làm giảm nguy cơ dụng cụ điện cầm tay khởi động bất ngờ.
- ▶ **Cất giữ dụng cụ điện cầm tay không dùng tới nơi trẻ em không lấy được và không cho người chưa từng biết dụng cụ điện cầm tay hay các hướng dẫn này sử dụng dụng cụ điện cầm tay.** Dụng cụ điện cầm tay nguy hiểm khi ở trong tay người chưa được chỉ cách sử dụng.
- ▶ **Bảo quản dụng cụ điện cầm tay. Kiểm tra xem các bộ phận chuyển động có bị sai lệch hay kẹt, các bộ phận bị rạn nứt và các tình trạng khác có thể ảnh hưởng đến sự vận hành của máy. Nếu bị hư hỏng, phải sửa chữa máy trước khi sử dụng.** Nhiều tai nạn xảy ra do bảo quản dụng cụ điện cầm tay tồi.
- ▶ **Giữ các dụng cụ cất bên và sạch.** Bảo quản đúng cách các dụng cụ cất có cạnh cắt bén làm giảm khả năng bị kẹt và dễ điều khiển hơn.
- ▶ **Sử dụng dụng cụ điện cầm tay, phụ kiện, đầu cài v. v., đúng theo các chỉ dẫn này, hãy lưu ý đến điều kiện làm việc và công việc phải thực hiện.** Sử dụng dụng cụ điện cầm tay khác với mục đích thiết kế có thể tạo nên tình huống nguy hiểm.

Sử dụng và bảo quản dụng cụ dùng pin

- ▶ **Chỉ được sạc pin lại với bộ nạp điện do nhà sản xuất chỉ định.** Bộ nạp điện thích hợp cho một loại pin có thể gây nguy cơ cháy khi sử dụng cho một loại pin khác.
- ▶ **Chỉ sử dụng dụng cụ điện cầm tay với loại pin được thiết kế đặc biệt dành riêng cho máy.** Sử dụng bất cứ loại pin khác có thể dẫn đến thương tật hay cháy.
- ▶ **Khi không sử dụng pin, để cách xa các vật bằng kim loại như kẹp giấy, tiền xu, chìa khóa, đinh, ốc vít hay các đồ vật kim loại nhỏ khác, thứ có thể tạo sự nối tiếp từ một đầu cực với một đầu cực khác.** Sự chập mạch của các đầu cực với nhau có thể gây bóng hay cháy.
- ▶ **Bảo quản ở tình trạng tối, dung dịch từ pin có thể tứa ra; tránh tiếp xúc. Nếu vô tình chạm phải, hãy xối nước để rửa. Nếu dung dịch vào mắt, cần thêm sự hỗ trợ của y tế.** Dung dịch tiết ra từ pin có thể gây ngứa hay bóng.

Bảo dưỡng

- ▶ **Đưa dụng cụ điện cầm tay của bạn đến thợ chuyên môn để bảo dưỡng, chỉ sử dụng phụ tùng đúng chủng loại để thay.** Điều này sẽ đảm bảo sự an toàn của máy được giữ nguyên.

30 | Tiếng Việt

Cảnh Báo An Toàn cho Máy Khoan và Bắt Vít

GSB 14,4 V-LI/GSB 18 V-LI

- ▶ **Hãy mang dụng cụ bảo vệ tai khi khoan với chế độ đập.** Phơi nhiễm tiếng ồn có thể làm cho tai bị điếc.

GSR 14,4 V-LI/GSR 18 V-LI/ GSB 14,4 V-LI/GSB 18 V-LI

- ▶ **Nắm dụng cụ điện nơi bề mặt nắm cách điện, khi vận hành ở nơi mà phụ tùng cắt hay các chi tiết lắp ráp có thể chạm vào dây điện được bắt đầu dây.** phụ tùng cắt hay các chi tiết lắp ráp chạm vào dây "có điện" làm các bộ phận kim loại phủ trần của dụng cụ điện "có điện" và có thể làm cho người vận hành bị điện giật.
- ▶ **Hãy sử dụng tay nắm phụ, nếu như được giao kèm với dụng cụ.** Sự mất điều khiển có thể gây thương tích cho bản thân.
- ▶ **Sử dụng thiết bị dò tìm thích hợp để xác định các đường hay ống dẫn công ích nằm âm trong khu vực làm việc hay liên hệ với Cty công trình phúc lợi để nhờ giúp đỡ.** Tiếp xúc với dây điện có thể dẫn đến cháy và bị điện giật. Chạm đường dẫn khí đốt có thể gây nổ. Làm thủng ống dẫn nước có thể làm hư hại tài sản hay có thể gây ra điện giật.
- ▶ **Tắt máy ngay lập tức khi dụng cụ lắp vào máy đột nhiên bị nghẽn chặt. Để phòng lực vận mạnh có thể được tạo ra do sự giật ngược.** Dụng cụ lắp vào có thể bị nghẽn chặt khi:
 - dụng cụ điện cầm tay bị quá tải hay
 - bị chèn chặt trong vật gia công.
- ▶ **Giữ máy bằng cách nắm thật chặt.** Lực vận ngược mạnh có thể xảy ra chớp nhoáng trong lúc bắt vít vào hay vặn ra.
- ▶ **Kẹp chặt vật gia công.** Vật gia công được kẹp bằng một thiết bị kẹp hay bằng ê-tô thì vững chắc hơn giữ bằng tay.
- ▶ **Giữ nơi làm việc của bạn gọn gàng.** Vật liệu có cấu tạo hỗn hợp là đặc biệt nguy hiểm. Bụi từ hợp kim nhẹ có thể cháy hay nổ.
- ▶ **Không được tháo pin ra.** Nguy cơ bị chập mạch.
 Bảo vệ pin không để bị làm nóng, ví dụ, chống để lâu dài dưới ánh nắng gay gắt, lửa, nước, và sự ẩm ướt.**Sự nguy hiểm của nổ.**
- ▶ **Trong trường hợp pin bị hỏng hay sử dụng sai cách, hơi nước có thể bốc ra. Hãy làm cho thông thoáng khí và trong trường hợp bị đau**

phải nhờ y tế chữa trị. Hơi nước có thể gây ngứa hệ hô hấp.

- ▶ **Chỉ sử dụng pin cùng chung với dụng cụ điện cầm tay Bosch của bạn.** Chỉ riêng với cách này đã bảo vệ cho pin không bị nguy hiểm do quá tải.
- ▶ **Chỉ sử dụng pin chính hãng Bosch có điện thế được ghi trên nhãn máy dụng cụ điện của bạn.** Khi sử dụng các loại pin khác, vd. hàng nhái, pin tân trang hoặc pin của hãng khác, có nguy cơ bị thương tích do pin gây ra cũng như làm hư hỏng tài sản do việc pin bị nổ.









Các Hướng Dẫn An Toàn và Vận Hành Bổ Sung

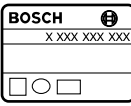







- ▶ **Bụi từ các vật liệu như là lớp phủ có chứa chì, một số loại gỗ, khoáng chất và kim loại có thể gây nguy hại đến sức khỏe và gây dị ứng, dẫn đến sự nhiễm trùng đường hô hấp và/hay gây ung thư.** Vật liệu chứa amiăng có thể chỉ nên để cho các thợ chuyên môn gia công.
 - Tạo không khí thông thoáng nơi làm việc.
 - Khuyến nghị nên mang mặt nạ phòng độc có bộ lọc cấp P2.
 Tuân thủ các qui định của quốc gia bạn liên quan đến loại vật liệu gia công.
- ▶ **Tránh không để rác tích tụ tại nơi làm việc.** Rác có thể dễ dàng bắt lửa.
- ▶ **Trước khi làm bất cứ công việc gì với máy (vd. bảo dưỡng, thay dụng cụ v. v..) cũng như trong quá trình vận chuyển và cất giữ, chỉnh đặt gạc chọn chiều quay về vị trí chính giữa.** Sự vô ý kích hoạt công tắc Tắt/Mở có thể dẫn đến thương tích.
- ▶ **Pin được cung cấp đã được nạp điện một phần. Để bảo đảm đầy đủ điện dung, nạp điện hoàn toàn lại cho pin trong bộ nạp điện pin trước khi sử dụng cho lần đầu tiên.**
- ▶ **Pin được trang bị bộ phận kiểm soát nhiệt độ NTC, bộ phận này chỉ cho phép nạp điện trong tầm nhiệt độ nằm giữa 0 °C và 45 °C.** Tuổi thọ lâu bền của pin đạt được nhờ vào cách thức này.
- ▶ **Hãy đọc hướng dẫn sử dụng bộ nạp điện pin.**
- ▶ **Chỉ được đặt dụng cụ điện cầm tay vào vít khi đã tắt máy.** Dụng cụ đang quay có thể bị tuột ra.
- ▶ **Điều chỉnh gạc chọn lực truyền động chỉ khi máy đã dừng hoàn toàn.**
- ▶ **Luôn luôn đẩy gạc chọn lực truyền động và vặn gạc chọn chế độ hoạt động cho đến tận cùng.** Nếu không, điều này có thể làm máy bị hư.

► Trong trường hợp gia tải quá mức, vd. dụng cụ ứng dụng bị chèn chặt kéo dài, bộ phận điện tử ngắt mạch dụng cụ điện. Sau khi mở máy lại, dụng cụ điện có thể được sử dụng lại đúng chức năng như đã chủ định. Trong trường hợp tiếp tục bị quá tải, dụng cụ điện sẽ lại tắt lần nữa để ngăn làm hư hỏng động cơ (motor).

Các Biểu Tượng

Các biểu tượng sau đây mang ý nghĩa quan trọng để suy diễn và hiểu các hướng dẫn sử dụng. Xin vui lòng lưu ý đến các biểu tượng và ý nghĩa của chúng. Sự hiểu đúng các biểu tượng sẽ giúp bạn sử dụng máy một cách tốt và an toàn hơn.

Biểu Tượng	Ý Nghĩa
	GSR 14,4 V-LI/GSR 18 V-LI/ GSB 14,4 V-LI/GSB 18 V-LI: Máy bắt vít pin/Kết hợp khoan pin Phạm vi có màu xám: Tay nắm (phần nắm được cách điện)
	Mã số máy X XXX XXX XXX
	Đọc tất cả các cảnh báo an toàn và mọi hướng dẫn
	Trước khi làm bất cứ việc gì với máy, hãy tháo pin ra
	Mang dụng cụ bảo vệ tai
	Chiều chuyển động
	Chiều phản ứng
	Khoan thường và bắt vít
	Khoan đập
	Tốc độ thấp

Biểu Tượng	Ý Nghĩa
	Tốc độ cao
I	Mở công tắc
O	Để tắt máy
	Quay Phải/Trái
U	Điện thế danh định
n_s	Tần suất đập
$n_0 1$	Tốc độ không tải (số 1)
$n_0 2$	Tốc độ không tải (số 2)
M	Lực vận tối đa theo tiêu chuẩn ISO 5393
	Công trình xây gạch
	Kim Loại
	Gỗ
\emptyset	Đường kính khoan, tối đa
\emptyset 	Đường kính vít tối đa
	Phạm vi mâm cặp kẹp được
	Trọng lượng theo Quy trình EPTA- Procedure 01:2014 (chuẩn EPTA 01:2014)
*	tùy vào loại pin lắp đang sử dụng

Các món được giao

Máy vận vít pin/Kết hợp khoan pin.

Pin, dụng cụ ứng dụng và các phụ kiện được trình bày hay mô tả khác không phải là một phần của tiêu chuẩn hàng hóa được giao.

Bạn có thể tìm thấy thông tin mô tả tổng quát các phụ kiện trong chương trình phụ kiện của chúng tôi.

Dành sử dụng cho

Máy được thiết kế để bắt và tháo vít cũng như khoan gỗ, kim loại, vật liệu bằng gốm và nhựa mù. Máy loại GSB được thiết kế thêm phần khoan đập dùng khoan gạch, công trình xây gạch và công trình nề.

Thông số kỹ thuật

Tính năng kỹ thuật của máy được liệt kê trong Bảng ở trang 33 của các hướng dẫn sử dụng này.

Xin vui lòng xem kỹ mã số máy trên nhãn máy của bạn. Tên thương mại của từng máy có thể khác nhau.

32 | Tiếng Việt

Lắp và Vận Hành

Loại công việc	Hình ảnh	Trang
Tháo Pin	1	34
Lắp Pin Vào	2	34
Gài lắp dụng cụ ứng dụng	3	34
Đảo Chiều Quay	4	35
Chỉnh đặc lực xoắn	5	35
Chọn lựa vị trí khoan	6	36
Chỉnh Đặt Phương Thức Hoạt Động	7	36
Sự chọn lực Truyền động, Cơ học	8	36
Mở và Tắt	9	37
Chọn phụ tùng	-	38

Bảo Dưỡng Và Làm Sạch

► **Để được an toàn và máy hoạt động đúng chức năng, luôn luôn giữ máy và các khe thông gió được sạch.**

Làm sạch dụng cụ ứng dụng, bộ phận gá lắp dụng cụ, các khe thông gió của dụng cụ điện, và các khe thông gió của pin sau mỗi lần sử dụng.

Dịch Vụ Sau Khi Bán và Dịch Vụ Ứng Dụng

Bộ phận phục vụ hàng sau khi bán của chúng tôi sẽ trả lời các câu hỏi liên quan đến việc bảo trì và sửa chữa các sản phẩm cũng như các phụ tùng thay thế của bạn. Hình ảnh chi tiết và thông tin phụ tùng thay thế có thể tìm hiểu theo địa chỉ dưới đây:

www.bosch-pt.com

Bộ phận dịch vụ ứng dụng Bosch sẽ hân hạnh trả lời các câu hỏi liên quan đến các sản phẩm của chúng tôi và linh kiện của chúng.

Trong mọi thư từ giao dịch và đơn đặt hàng phụ tùng, xin vui lòng luôn viết đủ 10 con số đã được ghi trên nhãn máy.

Việt Nam

Công ty Trách Nhiệm Hữu Hạn Robert Bosch Việt Nam, PT/SVN
Tầng 10, 194 Golden Building
473 Điện Biên Phủ
Phường 25, Quận Bình Thạnh
Thành Phố Hồ Chí Minh
Việt Nam
Tel.: (08) 6258 3690 Ext 413
Fax: (08) 6258 3692
hieu.lagia@vn.bosch.com
www.bosch-pt.com

Vận Chuyển

Pin có chứa lithium-ion là đối tượng phải tuân theo các qui định của Pháp Luật về Hàng Hóa Nguy Hiểm. Người sử dụng có thể vận chuyển pin bằng đường bộ mà không cần có thêm yêu cầu nào khác. Khi được vận chuyển thông qua bên thứ ba (vd. vận chuyển bằng đường hàng không hay đại lý giao nhận), phải tuân theo các yêu cầu đặc biệt về đóng gói và dán nhãn. Để chuẩn bị cho món hàng sẽ được gửi đi, cần tham khảo ý kiến của chuyên gia về vật liệu nguy hiểm.

Chỉ gửi pin đi khi vỏ ngoài không bị hư hỏng. Dán băng keo hay che kín các điểm tiếp xúc để hở và đóng gói pin cách sao cho pin không thể xô dịch khi nằm trong bao bì được.

Cũng xin vui lòng tuân theo qui định chi tiết có thể có của mỗi quốc gia.

Thải bỏ

 Máy, pin nạp điện lại được, phụ kiện và bao bì phải được phân loại để tái chế theo hướng thân thiện với môi trường.

Không được vứt bỏ dụng cụ điện, pin/pin nạp điện lại được vào chung với rác sinh hoạt!

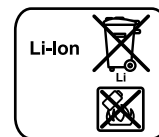
Pin lốc/pin:**Li-ion:**

Xin vui lòng tuân thủ theo thông tin dưới đây "Vận Chuyển", trang 32.

Được quyền thay đổi nội dung mà không phải thông báo trước.

		GSR 14,4 V-Li	GSR 18 V-Li	GSB 14,4 V-Li	GSB 18 V-Li
		3 601 H66 0..	3 601 H66 1..	3 601 H67 0..	3 601 H67 1..
U	V=	14,4	18	14,4	18
$n_0 1$	min ⁻¹	0 - 500	0 - 500	0 - 500	0 - 500
$n_0 2$	min ⁻¹	0 - 1600	0 - 1700	0 - 1600	0 - 1700
n_s	min ⁻¹	-	-	0 - 24000	0 - 25500
M	Nm	60	67	60	67
M	Nm	25*	28*	25*	28*
\emptyset	mm	-	-	13	13
\emptyset	mm	13	13	13	13
\emptyset	mm	32	35	32	35
\emptyset	mm	7	8	7	8
	mm	1,5 - 13	1,5 - 13	1,5 - 13	1,5 - 13
	kg	1,5 - 1,8*	1,6 - 2,1*	1,6 - 1,9*	1,7 - 2,2*

1

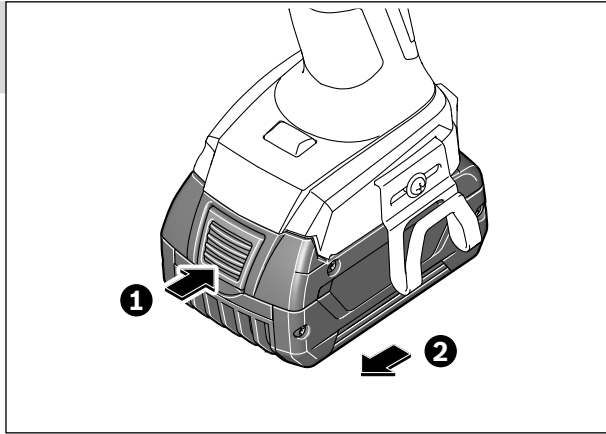
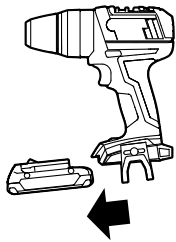

2

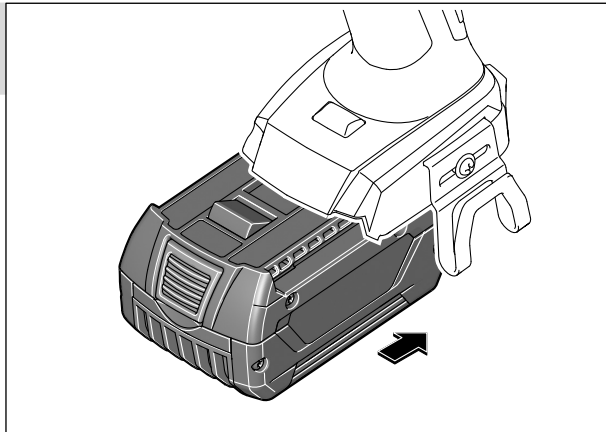
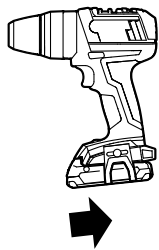

3

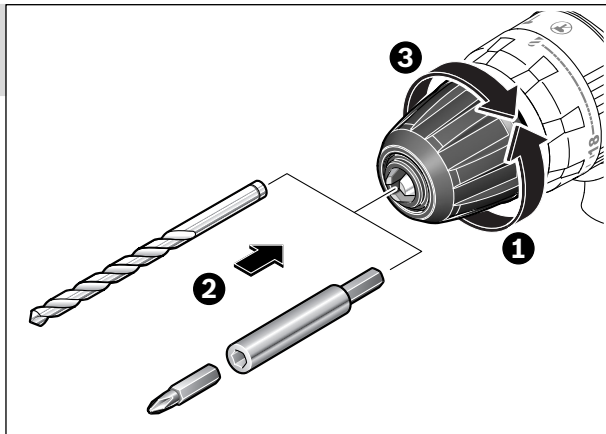
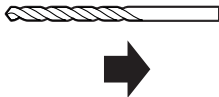

4

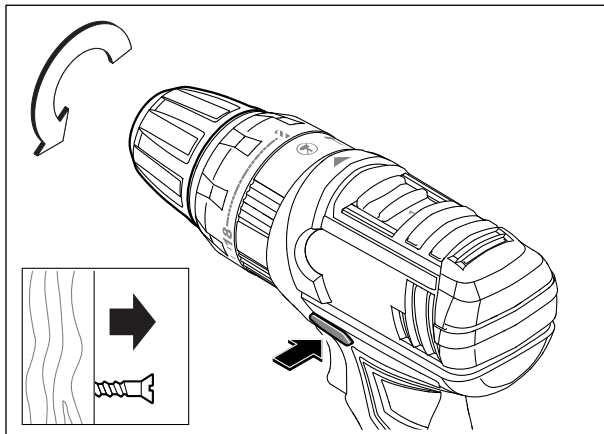
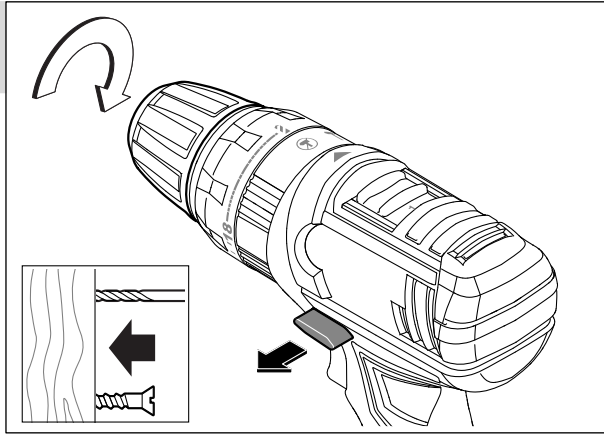
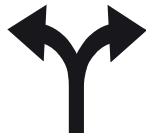

5

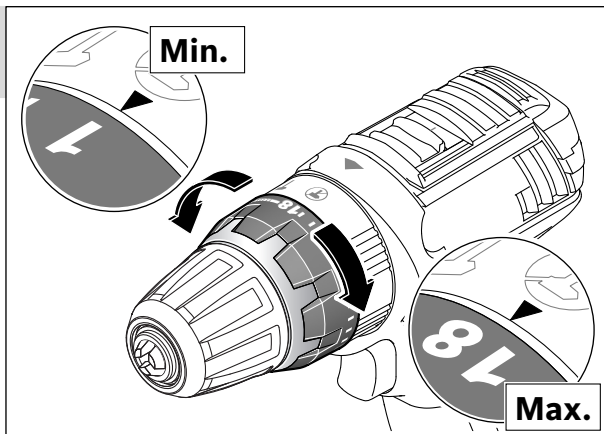

36 |

6

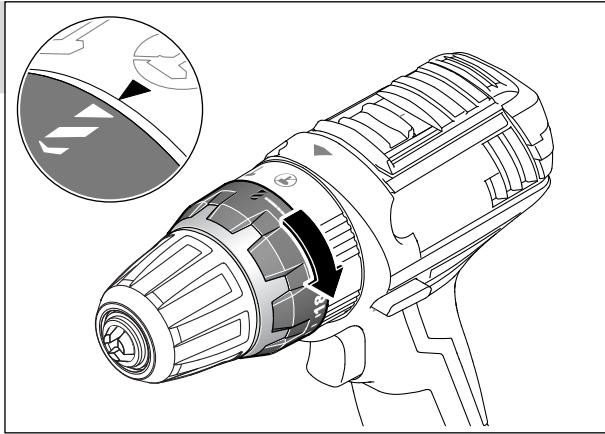

7

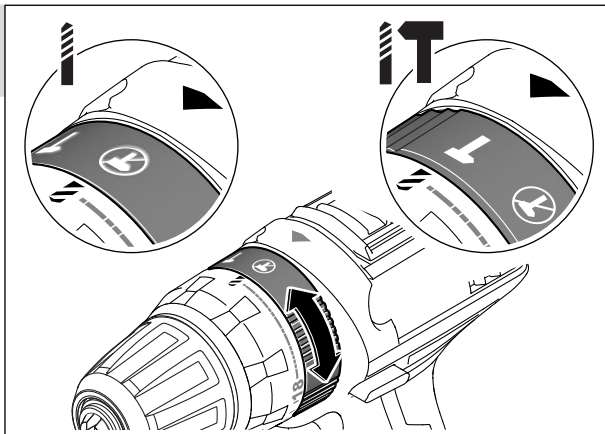

8

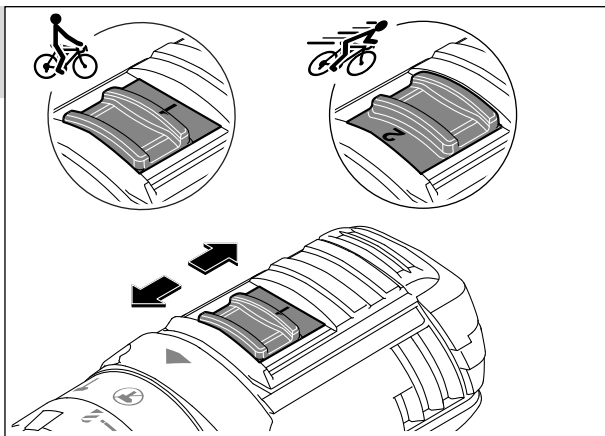
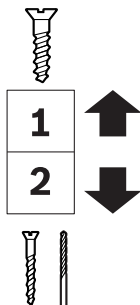

9

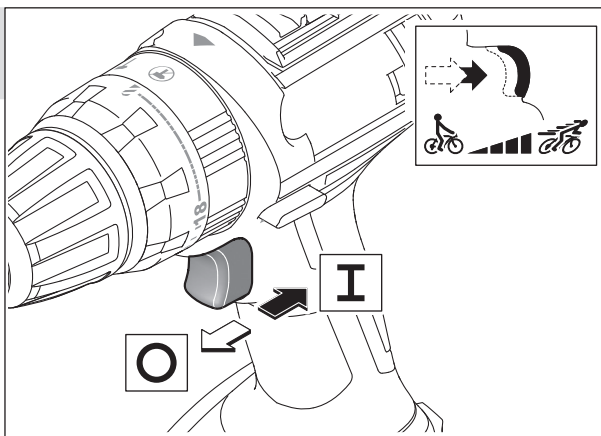



14,4 V (Li-Ion)

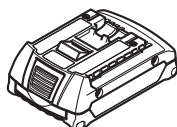
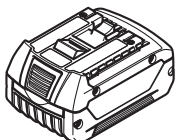

18 V (Li-Ion)

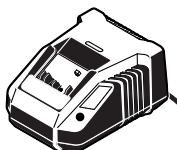

**AL 1820 CV
(14,4 / 18 V)**

2 607 225 440 (CN)
2 607 225 432 (TW)
2 607 225 436 (KR)
2 607 225 426 (MY, SG, HK)
2 607 225 424 (IN, TH, PH, VN (Far East))
2 607 225 428 (AU, NZ)



**AL 1860 CV
(14,4 / 18 V)**

2 607 225 337 (CN)
2 607 225 329 (TW)
2 607 225 333 (KR)
2 607 225 323 (MY, SG, HK)
2 607 225 321 (IN, TH, PH, VN (Far East))
2 607 225 325 (AU, NZ)